

Western Region

BULLETIN NO. 18



C_{AR}

L_{OCATION}

I_{DENTITY}

C_{ODES}

Instructions - Maps

Stockton Subdivision

Zones 04-06, 13 & 77-79

Revised February 1991

**ENGINEERING
SERVICES**
TOPPELA

WESTERN REGION CLIC BOOK ASSIGNMENTS AS OF SEPT 1990

CLIC BULLETIN NO.	TERRITORY COVERED
1	Cadiz-Needles-Ripley, Including Barstow Yard Tracks 0101-0165. Zones 50-52, 57-64, 66-74.
2	Lucerne Valley and Cajon Subs, Plus S.B. "A" YD Zones 02, 82-84.
3	S.B. Yards and Redlands Sub. Zones 01-05+83.
4	Pasadena Sub. Zones 13-17, 21+91
5	S.B. and Pasadena Subs. Zones 17-25.
6	S.B. Sub/Highgrove-Esperanza and San Jac Sub. Zones 30, 31+43.
7	Fullerton and Santa Ana, Zones 67, 69-72, 74-77, 81, 85-89+92.
8	S.B. Sub, LA Area, Zones 33-35, 37-39, 44-47.
9	S.B. Sub, LA Area, Zones 48-56.
10	S.B. Sub, LA Area, Zones 57-70.
11	Harbor Sub, Zones 29-32.
12	Harbor Sub, Zones 07-12.
13	San Diego and Escondido Subs, Zones 40-42, 46, 48-50, 78, 79+98.
14	Mojave and Bakersf Subs, Mainline SP Joint, Zones 01,08,65,66,71-76.
15	Bakersf, Arvin, Oil City Subs and Sunset Rlwy, Zones 01-05,09,11-14, 18+19.
16	Porterville, Visalia Subs, Including Oil Jct To Ducor, Zones 11,14,20-29+36.
17	Calwa-Fresno Industries, Fresno Interurban, Zones 51,52,55,57-59.
18	Stockton Sub, Zones 04-06,13,77-79.
19	Stockton-Mormon, Zones 01-03,79+89.
20	Richm, Oakland, S.F. Zones 01-11+23.
21 Final	Barstow Yards, Zones 01, 10-18.

CAR LOCATION IDENTITY CODES

This booklet contains instructions and maps for the Car Location Identity Code (CLIC) and procedures governing the Work Order Document System.

Maps are not drawn to scale and are to be used only as a guide to locating customer and yard tracks and the numbers assigned to them.

The geographical area covered in this booklet is divided into zones. Each zone has designated tracks and/or industries within its boundary.

A CLIC number will consist of six digits—the first two digits designate the zone; the second two digits indicate the track number within the zone; the last two digits represent the actual spot along the track.

The combination of the zone-track-spot number is known as the "Car Location Identity Code" (CLIC) System.

This "CLIC" number will be used for switching and reporting purposes rather than the industry or track name.

****EXAMPLE OF CLIC NUMBER****

01 20 04 — Spot Number
 _____ Track Number
 _____ Zone Number

All switch targets or stands have been painted with a combination of the zone and track number.

Spot numbers have been painted on doors, docks, buildings, gates, etc., wherever possible.

WORK ORDER DOCUMENT

Any written or verbal instructions issued to yard or road crews requiring work to be performed during their tour of duty will constitute a work order.

NOTE: Exceptions to written work orders must be noted on the work orders according to current instructions; cars handled on verbal work orders must be reported on the prescribed form.

Conductors and Engine Foremen will be furnished work orders during their tour of duty.

This document will specify the cars to be picked up or set out at various stations, industries or interchange tracks served by the train or switch job.

Certain information (described below) must be recorded on the work order document by the Conductor or Engine Foreman. Prior to turning in the document at the designated reporting station, it must be dated and signed—even if no work was accomplished. This is necessary to comply with switching and demurrage tariffs, as well as other rules and regulations.

Conductors and Engine Foreman must show on work order cars handled, time and date work performed, CLIC number taken from, CLIC number left and appropriate code as listed below:

- BO - Bad order
- ND - Work indicated not done (State reason.)
- NIT - Car not in train or not on track
- OTCC- Car on track, carriers convenience
- OTNP- Car on track not placed (State reason.)
- PULL- Car pulled, time and date
- SPOT- Car spotted, time and date

Conductor/Engine Foreman must make notation on work order and notify the appropriate employe (S/O, RYO clerk, Dispatcher) of any exceptions taken to the work order, such as no car, car not on list, car out of line, car is hazardous, excess dimension (when the information is not so indicated on work order), car is carded rear or head end movement, or any other exceptions noted.

If switching is performed without a work order, the Conductor or Engine Foreman must complete the prescribed form showing all the information required above and turn it in at the designated reporting station.

If an industry requests service not shown on work order, Conductor/Engine Foreman should obtain such request in writing. This request is to be turned in with work order for processing. If unable to obtain request in writing, Conductor/Engine Foreman should record on work order the name of person making request and the service requested and performed.

For observation and guidance, the following codes may appear on work order.

- AI - Agri. Industries
- B1 - Bad Order
- BA - Blasting Agent (Hazardous)
- CG - Cargill
- CD - Condemned
- CB - Combustible (Hazardous)
- CL - Chlorine (Hazardous)
- CM - Corrosive (Hazardous)
- DG - Dangerous
- DH - Do Not Hump
- DU - Do Not Uncouple
- EQ - Equity Export - Houston
- FG - Flammable Gas (Hazardous)
- FL - Flammable (Hazardous)
- FS - Flammable Solid (Hazardous)
- FW - Flam. Solid W (Dangerous When Wet)
- HE - Head End Only
- HL - High Wide Load
- PE - Houston Public Elevator
- HV - High Value
- IP - Interchange Prohibited
- IPSW - Intraplant Switch (Respot Car)
- MR - Mech. Refrig. Maintain - Degrees
- MCNR - Mech. Car or Trailer - No Refrigeration Required
- NG - Non-Flammable Gas (Hazardous)
- NP - No Placards Required
- OM - Oxidizer (Hazardous)
- OP - Organic Peroxide (Hazardous)
- OR - Other Regulated Material
- OX - Oxygen
- PA - Poison Gas (Hazardous)
- PB - Poison
- RE - Rear End Only
- RM - Radioactive Material
- REJT - Car Rejected by Shipper
- RSPT - Respot Due to Railroad Error
- TURN - Turn Car & Respot
- WH - Weight Heavy
- WI - Waive Inspection - Set Direct
- WL - Weigh Light
- XA - Explosive "A"
- XB - Explosive "B"
- XX - DO NOT MOVE THIS CAR

069800 500 Runaround
775900 A. M. Forest Prods.
052800 ADK
137100 Acid Spur
130701-90 Acme Transportation
130607-08 American Standard
130900 American Standard
050901 Antioch 24
053600 Antioch Link
133501-06 Asbury Graphite
130400 Atlas Foundry
773400 B&C Ranch
786090 B.A.C. Pritchard
786095 B.A.C. Pritchard
774700 Back Track
777100 Back Track
061100 Back Track
788000 Ballico Siding
775200 Baltimore Air Coil
064100 Below Storage 4
064200 Below Storage 5
131390-92 Bethlehem Steel
131490-92 Bethlehem Steel
131590-92 Bethlehem Steel
131690-92 Bethlehem Steel
131790-92 Bethlehem Steel
131990-92 Bethlehem Steel
132090-92 Bethlehem Steel
132190-92 Bethlehem Steel
785501-05 Bianci & Sons
785401-05 Bianci & Sons Drill
041800 Bixler Siding
783501-08 California Cannery Drill
783601-10 California Cannery House
796200 Carnation Can Co.
797200 Carnation Can Co.
797300 Carnation Can Co.
786600 Castle A.F.B.
786801 Castle A.F.B.
786894 Castle A.F.B.
786900 Castle A.F.B.
787000 Castle A.F.B.
787200 Castle A.F.B. Drill
133800 Christie Siding
133191 Collier Carbon
133290 Collier Carbon
133390 Collier Carbon
132800 Collier Siding
060400 Cont. Fibre Drum
060500 Cont. Fibre Drum
065100 Cont. Litho
065200 Cont. Litho
797800 Contadina Foods
797900 Contadina Foods
794100 Contadina Syrup
135300 Contra Costa Sanitary

135400 Contra Costa Sanitary
135500 Contra Costa Sanitary
135700 Contra Costa Sanitary
135900 Contra Costa Sanitary
136000 Contra Costa Sanitary
136100 Contra Costa Sanitary
136200 Contra Costa Sanitary
136300 Contra Costa Sanitary
785201-03 Coors Beer
061902 Cumberland Lumber
790200 Denair Lumber
790100 Denair Siding
064700 Diablo Seaways
784600 Dock Track
1318 Donico Company
069300 Dow Chemical
069400 Dow Chemical
069500 Dow Chemical
069600 Dow Chemical
069700 Dow Chemical
066000 Dow Chemical
066100 Dow Chemical
066200 Dow Chemical
066300 Dow Chemical
066400 Dow Chemical
066500 Dow Chemical
066600 Dow Chemical
066700 Dow Chemical
066800 Dow Chemical
066900 Dow Chemical
067000 Dow Chemical
067100 Dow Chemical
067200 Dow Chemical
067300 Dow Chemical
067400 Dow Chemical
067500 Dow Chemical
067600 Dow Chemical
067700 Dow Chemical
067800 Dow Chemical
067900 Dow Chemical
068000 Dow Chemical
068100 Dow Chemical
068200 Dow Chemical
068300 Dow Chemical
068400 Dow Chemical
069100 Dow Chemical
069200 Dow Chemical
069800 Dow Runaround
064300 Dow Running SN Main
799700 Duffy Siding
040100 Dupont Inbound
040500 Dupont Outbound
040600 Dupont Siding
040200 Dupont Storage
040300 Dupont Storage

040400 Dupont Storage
040700 Dupont Storage
040800 Dupont Storage
040900 Dupont Storage
041000 Dupont Storage
041100 Dupont Storage
041200 Dupont Storage
796300 Durabuilt Truss Co.
1315 East End Strip Track 2
795800 East Leg of Wye
792100 East MET Main Line
792000 East Yard #1
792200 East Yard #2
792300 East Yard #3
792400 East Yard #4
792500 East Yard #5
792600 East Yard #6
792700 East Yard #7
792900 East Yard #8
792800 Empire Siding
061400 Engine Spur
797100 Engine Track
799300 Escalon Packers
799100 Escalon Siding
791000 FMC Corp.
065901-02 Feralloy
065400 Feralloy Pipe Mill Lead
772000 Figarden Siding
786400 Fluhr Siding
790900 Foremost Foods
058100 Fulton Shipyard
058200 Fulton Shipyard
132300 Gateley Siding
058600 Gaylord Container
052100 Gaylord Container
052200 Gaylord Container
052300 Gaylord Container
052400 Gaylord Container
052500 Gaylord Container
052600 Gaylord Container
052700 Gaylord Container
054100 Gaylord Container
054200 Gaylord Container
054300 Gaylord Container
054400 Gaylord Container
054500 Gaylord Container
054600 Gaylord Container
055000 Gaylord Container
055100 Gaylord Container
055200 Gaylord Container
050400 Gaylord Container Box Plant
050600 Glass Containers
050700 Glass Containers
134200 Glen Frazer Siding
783201-03 Goodyear Drill
783301-03 Goodyear House

783100 Goodyear Lead
773000 Gregg Siding
775400 Guerra Iron & Metal
784701-05 Hadley Yosemite Farms
798900 Hershey Foods
799000 Hershey Foods
051200 Hickmott
798100 Hill Track #1
798200 Hill Track #2
798300 Hill Track #3
041500 House
790700 Hughson Siding
798600 Hunts Bulk Paste
798700 Hunts Canned Goods
798800 Hunts Canned Goods
052000 Imperial West Chem.
065501-02 Imperial West Chem.
065600 Imperial West Chem.
065700 Imperial West Chem.
799900 J. R. Simplot
799200 Jess Welch
063104 Johns-Mansville
063206 Johns-Mansville
063300 Johns-Mansville
063401 Johns-Mansville
063505 Johns-Mansville
051900 Kaiser Gypsum Domtar
776500 Kismet Siding
041700 Knightsen Siding
052900 L&M Pallet
053000 L&M Pallet
775500 L. A. Pacific
775600 L. A. Pacific
775700 L. A. Pacific
777500 Le Grand Siding
777999 Le Grand Team Track
795500 Lead Track
050300 Lead and House
062800 Link Hill Yd. Ext.
136900 Liquid Carbonics
777801-05 Live Oak Farms
777900 Live Oak Farms
133590 Loprest Co.
791000 M&M Chemical
774600 Madera Siding
134900 Maltby Siding
784000 McLane Industries
784100 McLane Industries
785091 Merced Bulk Storage
785094 Merced Bulk Storage
785095 Merced Bulk Storage
778594 Merced Milling
784300 Merced Siding
784500 Merced Team Track
061200 Middle Track

793400 Monolith Cement
795600 Monotherm Insulation
137600 Monsanto Chemical Acid Tank
137300 Monsanto Chemical Warehouse
137000 Monsanto Siding
774400 Norby Lumber Company
795900 Norris Industries
796000 Norris Industries
060300 North Lead
798400 Oakdale Team Track
041400 Oakley Siding
778301-03 Oasis Foods
042100 Orwood House Track
042000 Orwood Siding
7776 Out of Service
7777 Out of Service
796500 Out of Service
796600 Out of Service
796700 Out of Service
061500 P. G. & E.
061600 P. G. & E.
061700 P. G. & E.
783701 P. G. & E.
056400 P.G. & E.
056500 P.G. & E.
799200 Pac Coast Chemical
132700 Pinole House Track
062700 Pitts House Track
060200 Pittsburg Siding
061901 Pittsburg Whlse. Groc.
778600 Planada Siding
053700 Plant 7 Lead
054000 Plant 7 Runaround
138400 Pt. Chicago Yard
138100 Pt. Chicago Yard Long 1
138200 Pt. Chicago Yard Long 2
138300 Pt. Chicago Yard Long 3
138000 Pt. Chicago Yard Siding
793500 Puregrow Chemical
790200 Rainbow Farms
776793 Raymond Granite
063000 Redwood Lead
063000 Redwood Lead Johns Manville
130200 Rheem Siding
796800 Rip #5
796900 Rip #6
794000 Riverbank Siding
772200 Roberts Fig Team
775100 Runaround
782500 Runaround
783900 Runaround
784400 Runaround
785600 Runaround
786500 Runaround
787100 Runaround
798500 Runaround

778200 Runaround
063800 Running Track
130100 S. P. Lead
058500 Sag Track
053500 Sando - East
051700 Sando Siding
060600 Santa Fe - S.P. Transfer
060700 Santa Fe - S.P. Transfer
060800 Santa Fe - S.P. Transfer
060900 Santa Fe - S.P. Transfer
061000 Santa Fe - S.P. Transfer
797000 Scale Track
777000 Sharon Siding
138800 Short 1
1312 Siding
061300 Signode
065800 Specialinsup
799400 Standard Oil
065301-04 Stauffer Chem.
788100 Storage
041600 Storage
051800 Storage
050500 Storage
050800 Storage
051300 Storage
051400 Storage
051500 Storage
062000 Storage
134000 Storage
134100 Storage
133000 Storage
131200 Storage
132200 Storage
058000 Storage - Link
775800 Storage 1
776000 Storage 3
062600 Tail Track
797500 Team Track
796100 Thunderbolt Wood Treating
137500 Tosco Chemical
136700 Tosco Refinery
135000 Tosco Refinery
135100 Tosco Refinery
136600 Tosco Refinery Catalyst
136500 Tosco Refinery Coker
774000 Trigo Runaround
782601-08 Tuttle Farms
139800 U. S. Navy Bullpen
139900 U. S. Navy Bullpen
063900 U.S.S. Inbound Excess
064000 U.S.S. Outbound
063700 U.S.S. Wire Rope Dock
063600 U.S.S. Wire Rope Scale
773200 Vacant
774100 Vacant

783800	Vacant
790300	Vacant
790800	Vacant
130300	Vacant
776600	Valley Grain Products
793800	Valley Lift 1
793900	Valley Lift 2
041900	Werner Siding
1314	West End Strip Track 1
1316	West End Strip Track 2
798000	West Leg of Wye & M.L.
793000	West Yard #1
793100	West Yard #2
793200	West Yard #3
793300	West Yard #4
053400	Western Tin Plate
053100	Yard
053200	Yard
053300	Yard
795000	Yard #10
795100	Yard #11
794200	Yard #2
794300	Yard #3
794400	Yard #4
794500	Yard #5
794600	Yard #6
794700	Yard #7
794800	Yard #8
794900	Yard #9
062100	Yard 1
062200	Yard 2
062300	Yard 3
062400	Yard 4
062500	Yard 5
056200	Yard East Antioch
056300	Yard East Antioch
056100	Yard East Antioch

772000 Figarden Siding
772200 Roberts Fig Team
773000 Gregg Siding
773200 Vacant
773400 B&C Ranch

-1-

C.E. No. 11361-SK Engineering Services - Topoko 2/91

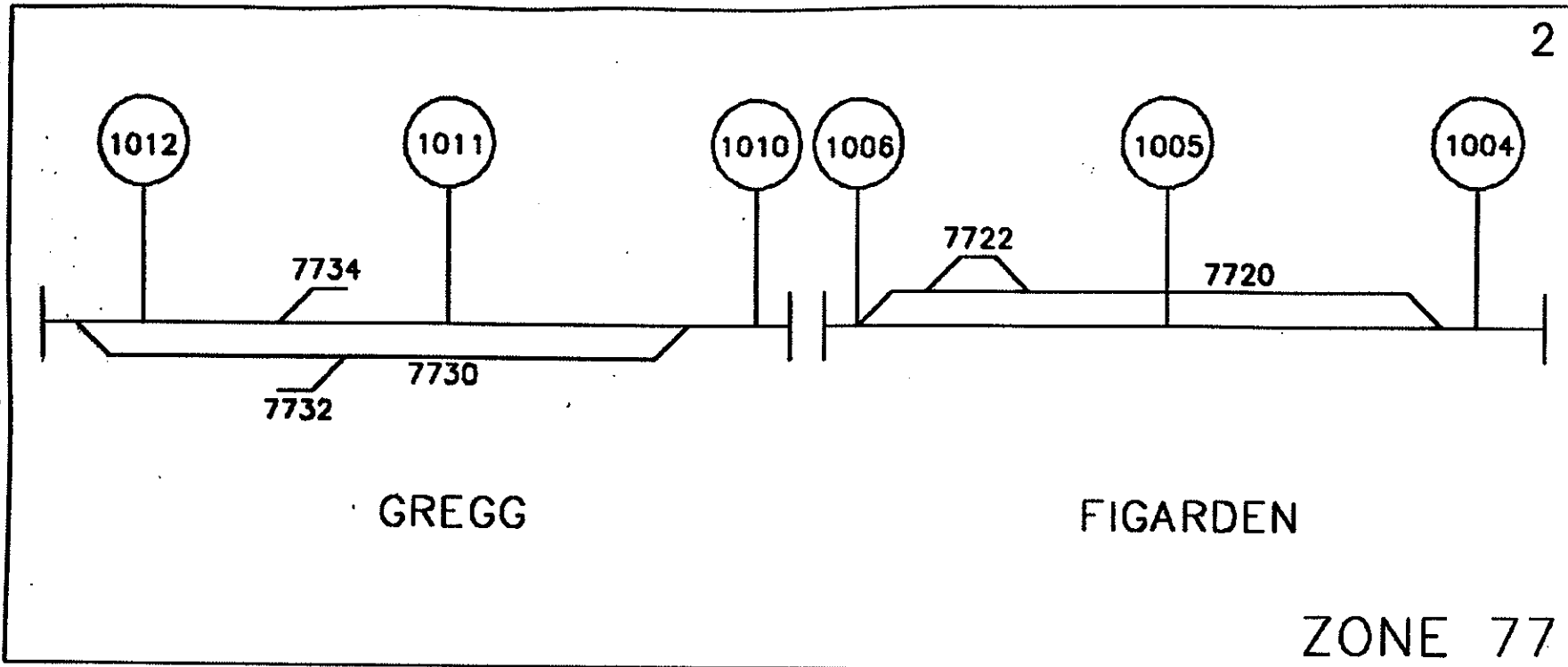

774000	Trigo Runaround
774100	Vacant
774400	Norby Lumber Company
774600	Madera Siding
774700	Back Track
775100	Runaround
775200	Baltimore Air Coil
775400	Guerra Iron & Metal
775500	L. A. Pacific
775600	L. A. Pacific
775700	L. A. Pacific
775800	Storage 1
775900	A. M. Forest Prods.
776000	Storage 3

-3-

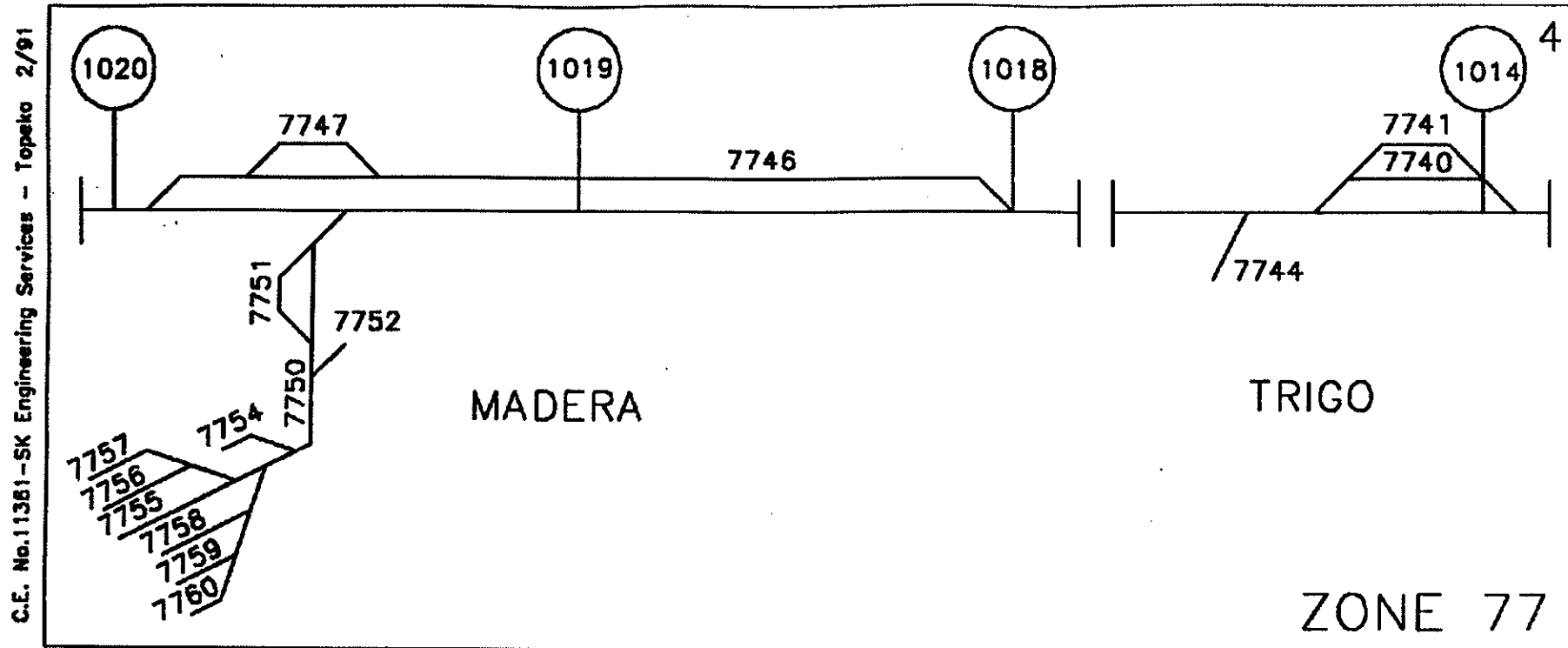

776500 Kismet Siding
776600 Valley Grain Products
776793 Raymond Granite
777000 Sharon Siding
777100 Back Track

-5-

C.E. No. 11361-SK Engineering Services - Topoka 2/91

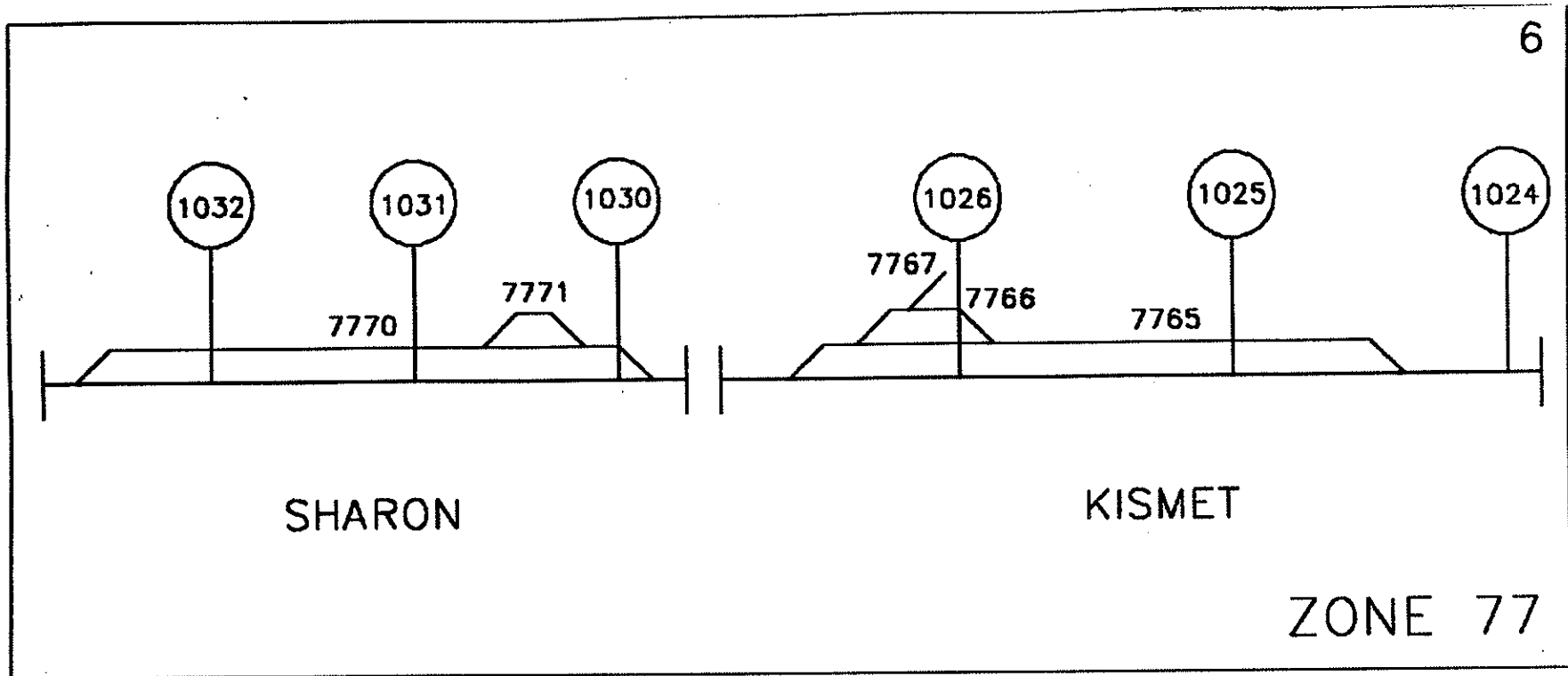

777500 Le Grand Siding
 7776 Out of Service
 7777 Out of Service
 777801-05 Live Oak Farms
 777900 Live Oak Farms
 777999 Le Grand Team Track
 778200 Runaround
 778301-03 Oasis Foods
 778594 Merced Milling
 778600 Planada Siding

-7-

C.E. No. 11381-SK Engineering Services - Topeta 2/91

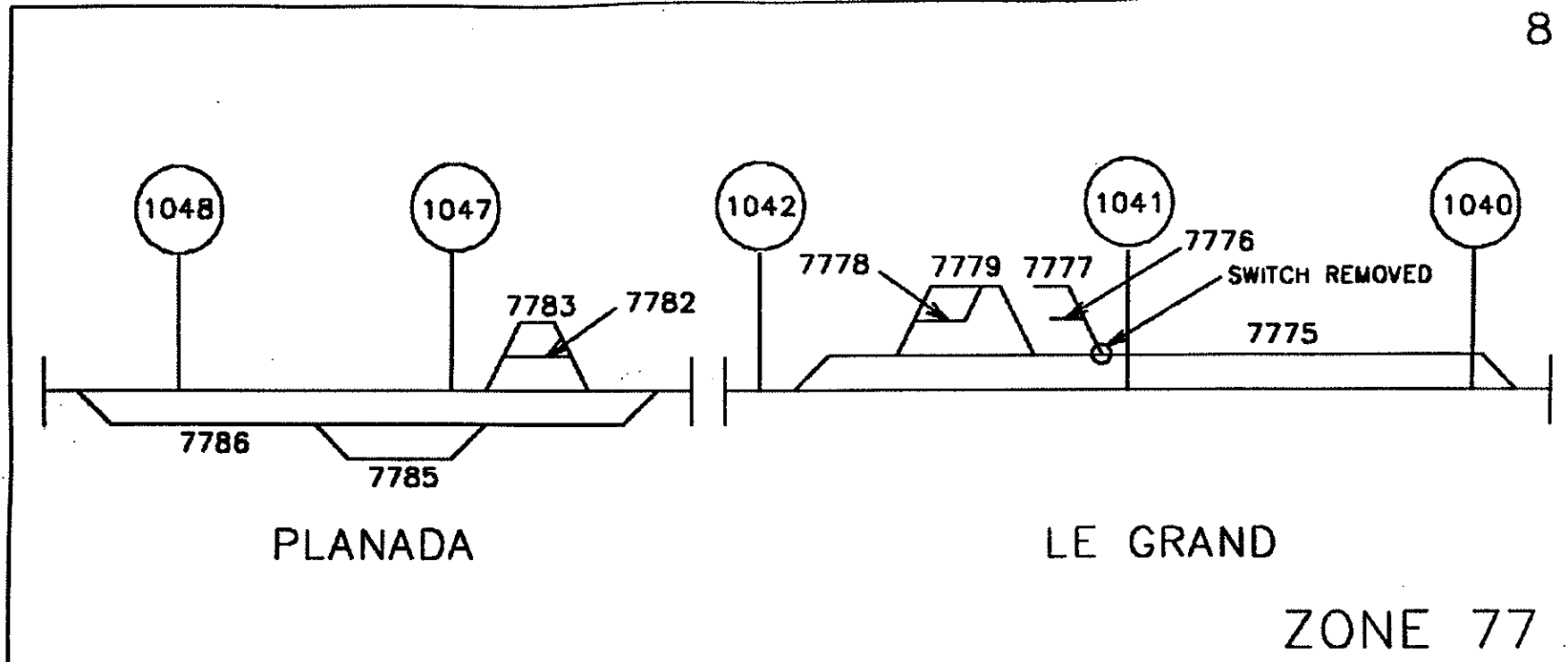

- 782500 Runaround
- 782601-08 Tuttle Farms
- 783100 Goodyear Lead
- 783201-03 Goodyear Drill
- 783301-03 Goodyear House
- 783501-08 California Cannery Drill
- 783601-10 California Cannery House
- 783701 P. G. & E.
- 783800 Vacant
- 783900 Runaround
- 784000 McLane Industries
- 784100 McLane Industries
- 784300 Merced Siding
- 784400 Runaround
- 784500 Merced Team Track
- 784600 Dock Track
- 784701-05 Hadley Yosemite Farms

C.E. No. 11361-SK Engineering Services - Topeka 2/91

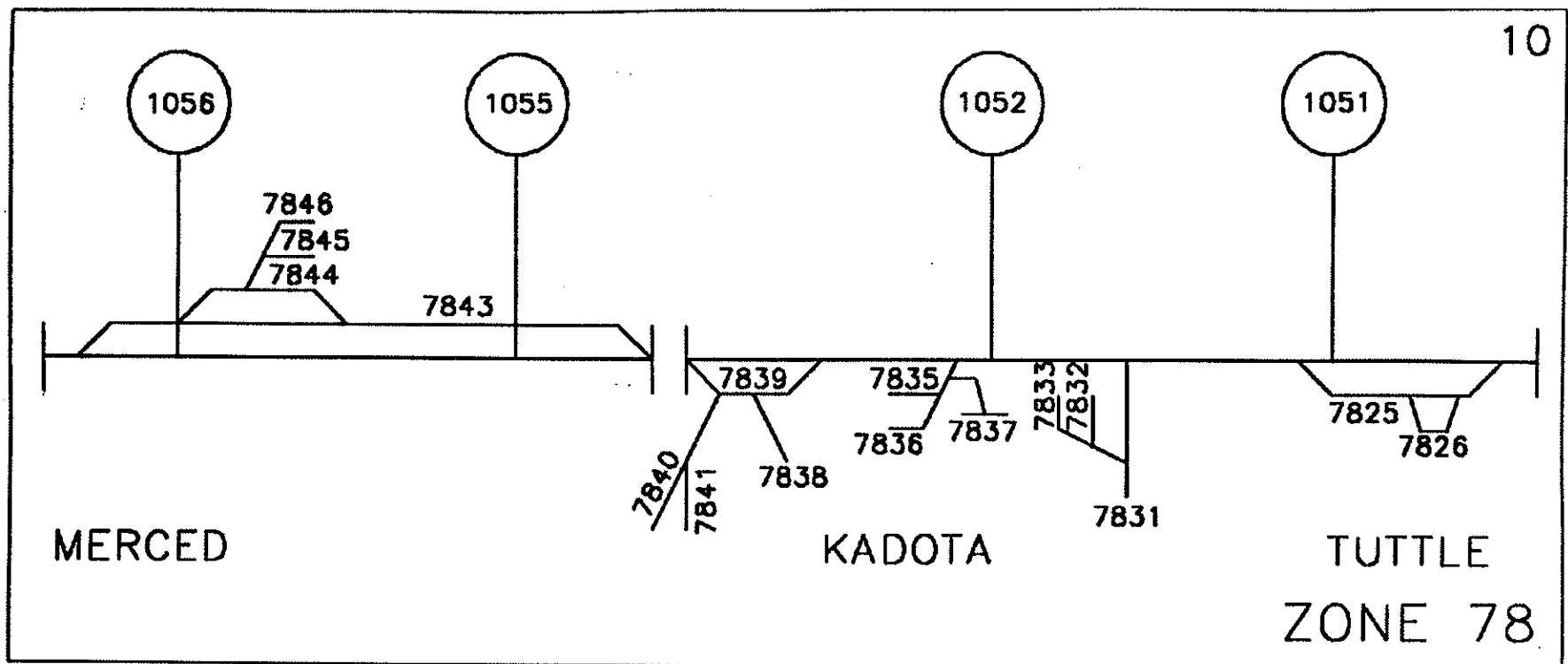

785091 Merced Bulk Storage
 785094 Merced Bulk Storage
 785095 Merced Bulk Storage
 785201-03 Coors Beer
 785401-05 Bianci & Sons Drill
 785501-05 Bianci & Sons
 785600 Runaround
 786090 B.A.C. Pritchard
 786095 B.A.C. Pritchard
 786400 Fluhr Siding
 786500 Runaround
 786600 Castle A.F.B.
 786801 Castle A.F.B.
 786894 Castle A.F.B.
 786900 Castle A.F.B.
 787000 Castle A.F.B.
 787100 Runaround
 787200 Castle A.F.B. Drill

-11-

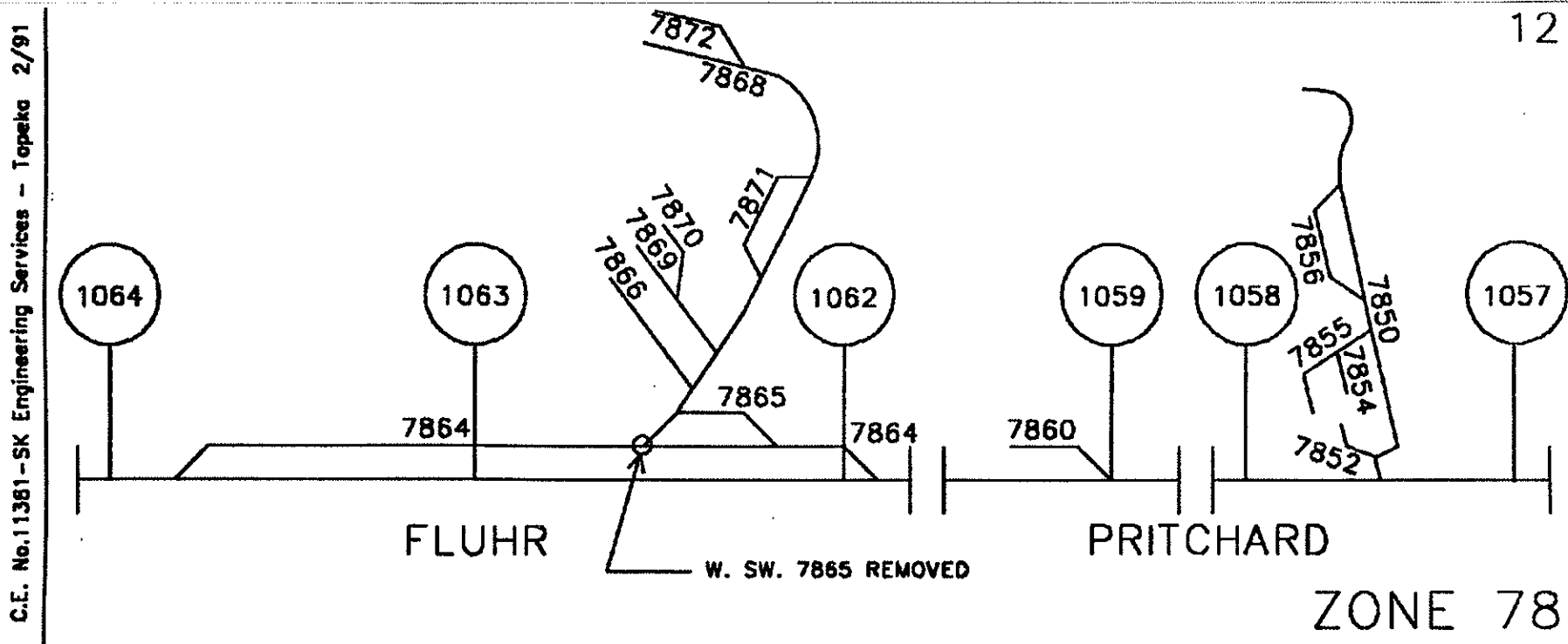

788000	Ballico Siding
788100	Storage
790100	Denair Siding
790200	Denair Lumber
790200	Rainbow Farms
790300	Vacant

-13-

C.E. No. 11361-SK Engineering Services - Topoka 2/91

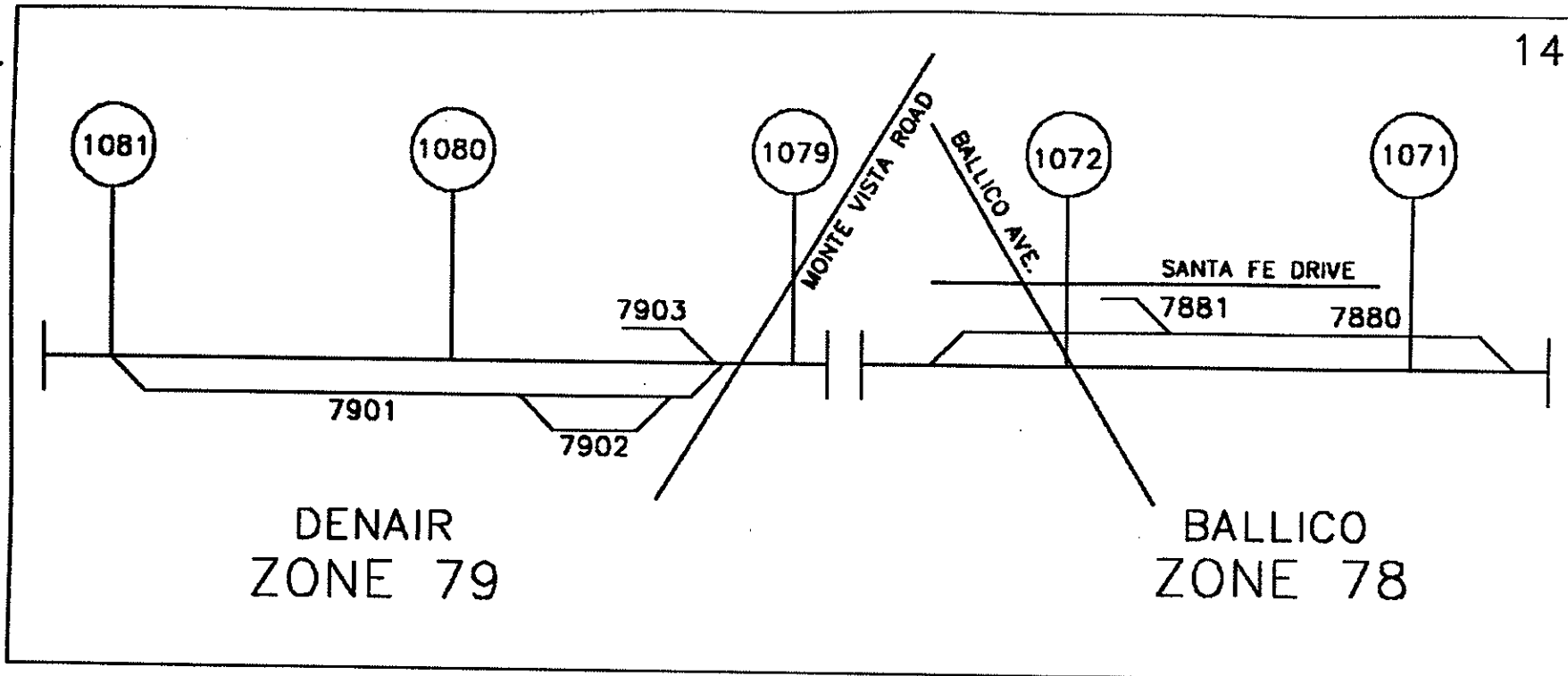

790700	Hughson Siding	792900	East Yard #8
790800	Vacant	793000	West Yard #1
790900	Foremost Foods	793100	West Yard #2
791000	FMC Corp.	793200	West Yard #3
791000	M&M Chemical	793300	West Yard #4
792000	East Yard #1	793400	Monolith Cement
792100	East MET Main Line	793500	Puregrow Chemical
792200	East Yard #2	793800	Valley Lift 1
792300	East Yard #3	793900	Valley Lift 2
792400	East Yard #4		
792500	East Yard #5		
792600	East Yard #6		
792700	East Yard #7		
792800	Empire Siding		

-15-

C.E. No. 11381 - SK Engineering Services - Topoka 2/91

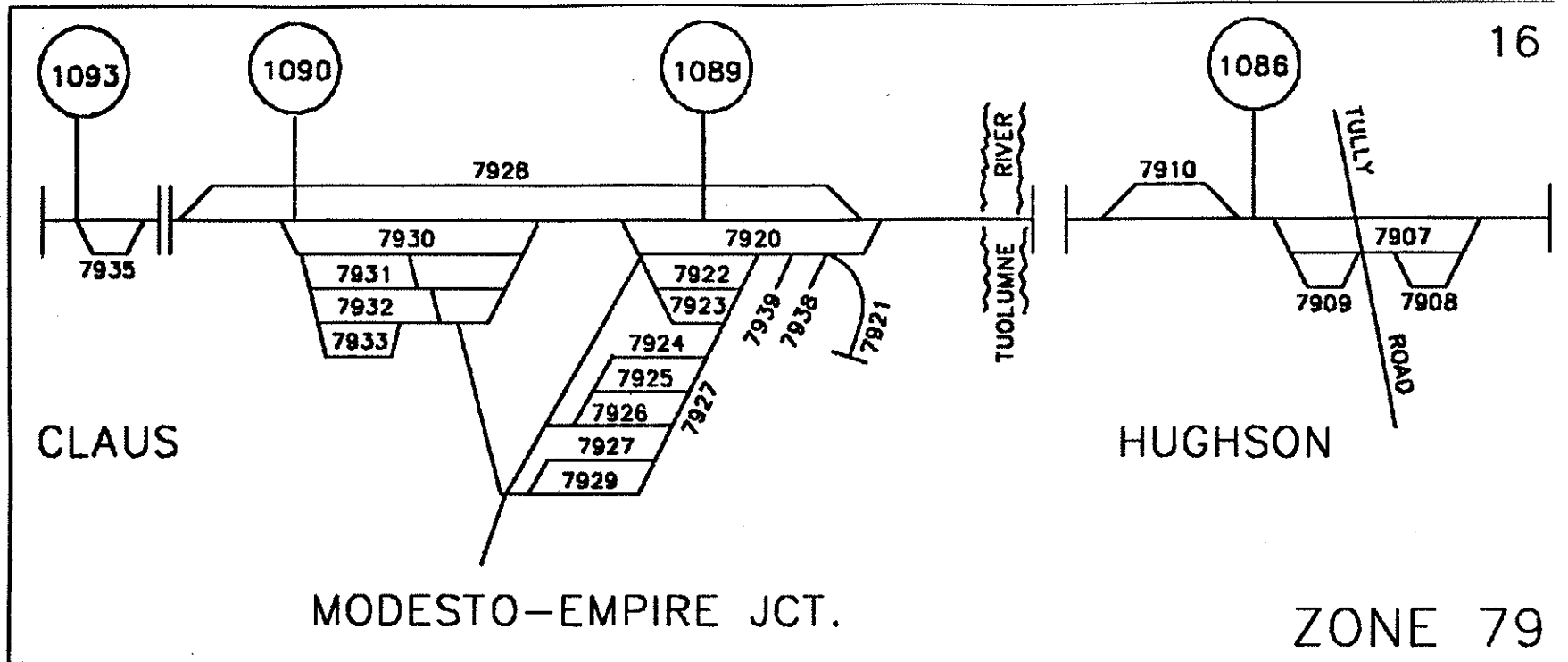

794000	Riverbank Siding	796300	Durabuilt Truss Co.	798600	Hunts Bulk Paste
794100	Contadina Syrup	796500	Out of Service	798700	Hunts Canned Goods
794200	Yard #2	796600	Out of Service	798800	Hunts Canned Goods
794300	Yard #3	796700	Out of Service	798900	Hershey Foods
794400	Yard #4	796800	Rip #5	799000	Hershey Foods
794500	Yard #5	796900	Rip #6		
794600	Yard #6	797000	Scale Track		
794700	Yard #7	797100	Engine Track		
794800	Yard #8	797200	Carnation Can Co.		
794900	Yard #9	797300	Carnation Can Co.		
795000	Yard #10	797500	Team Track		
795100	Yard #11	797800	Contadina Foods		
795500	Lead Track	797900	Contadina Foods		
795600	Monotherm Insulation	798000	West Leg of Wye & M.L.		
795800	East Leg of Wye	798100	Hill Track #1		
795900	Norris Industries	798200	Hill Track #2		
796000	Norris Industries	798300	Hill Track #3		
796100	Thunderbolt Wood Treating	798400	Oakdale Team Track		
796200	Carnation Can Co.	798500	Runaround		

-17-

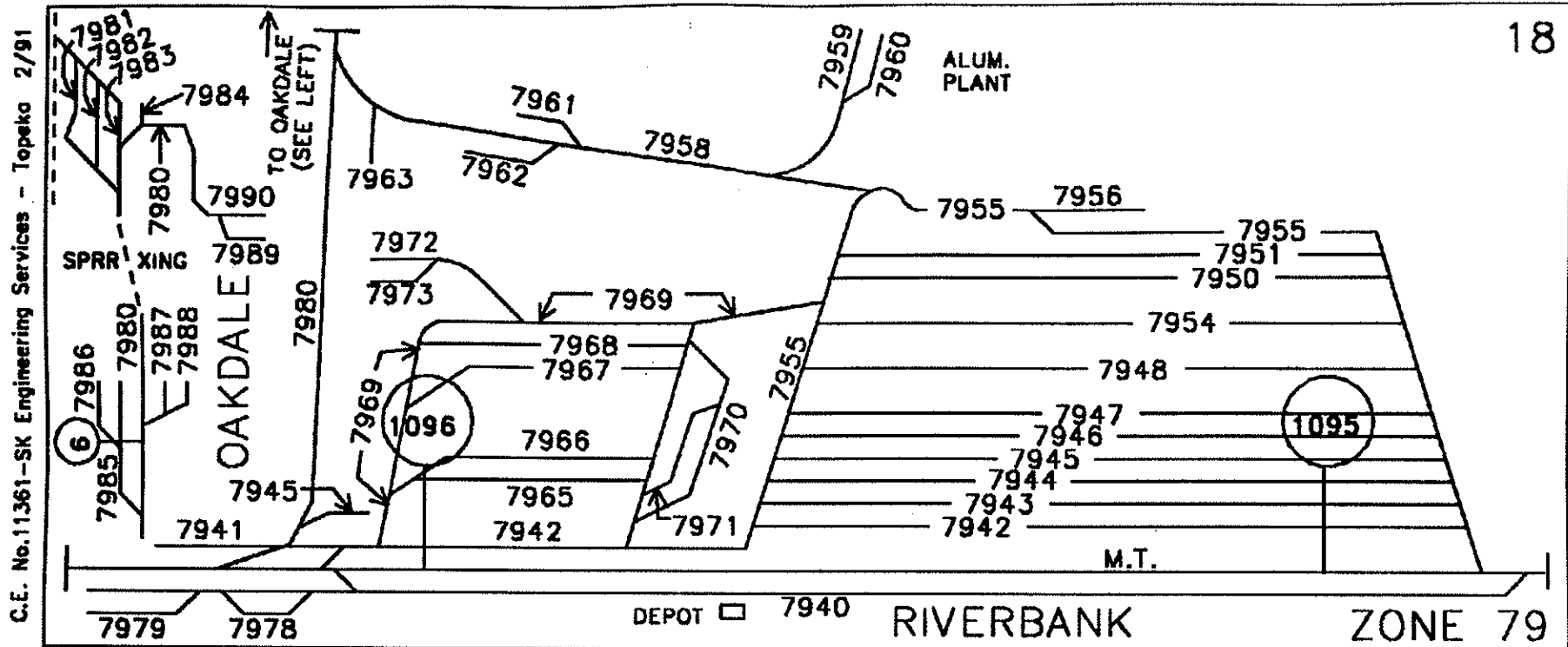

799100 Escalon Siding
 799200 Jess Welch
 799200 Pac Coast Chemical
 799300 Escalon Packers
 799400 Standard Oil
 799700 Duffy Siding
 799900 J. R. Simplot

-19-

C.E. No. 11381 - SK Engineering Services - Topeka 2/91

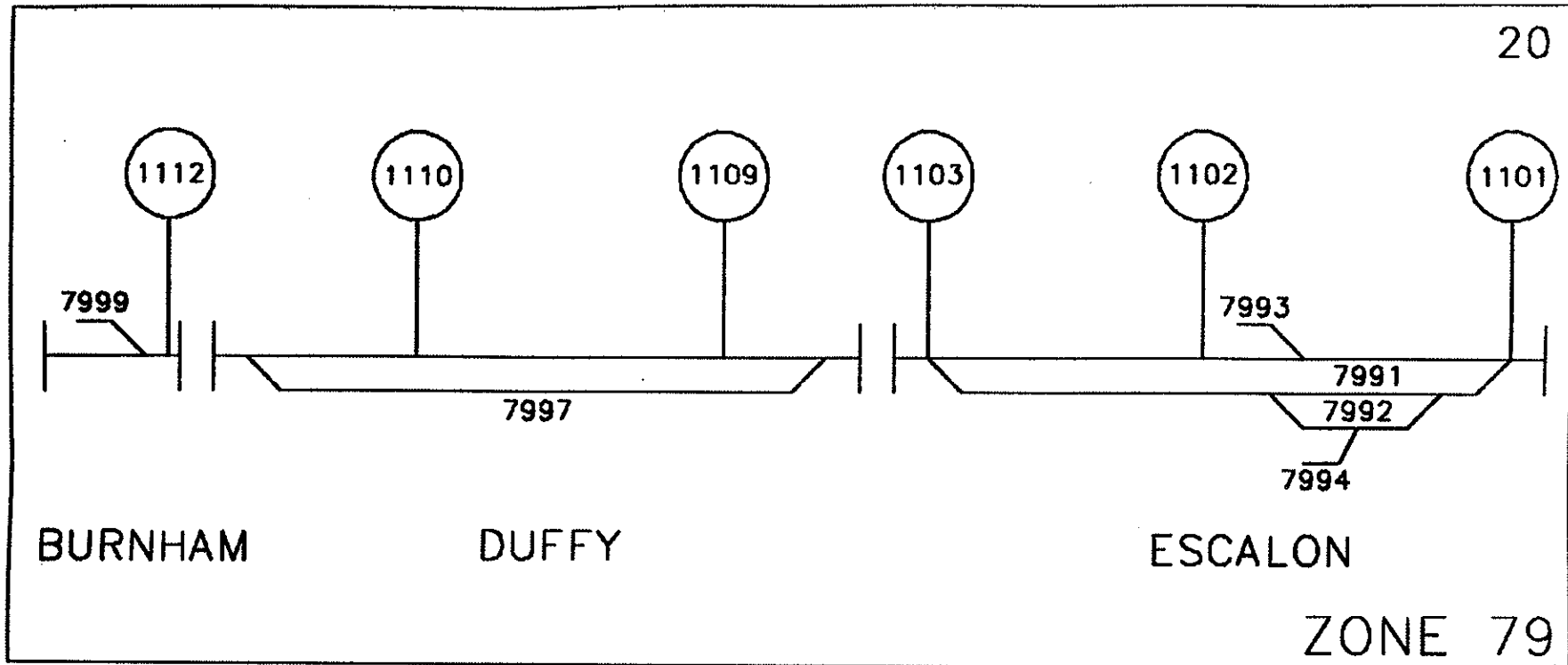

ZONE 4

- 041500 House
- 041600 Storage
- 041700 Knightsen Siding
- 041800 Bixler Siding
- 041900 Werner Siding
- 042000 Orwood Siding
- 042100 Orwood House Track

-21-

C.E. No. 11361-SK Engineering Services - Topoka 2/91

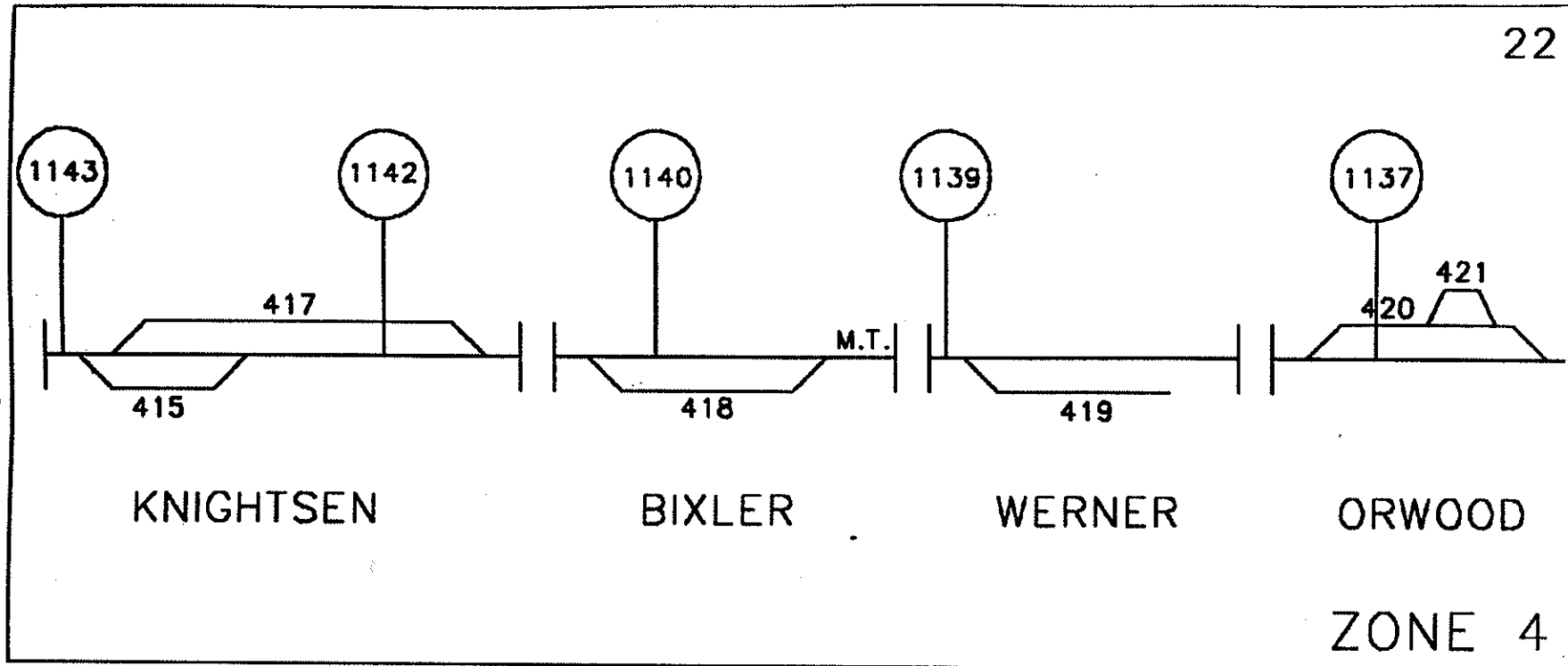

ZONE 4

040100	Dupont Inbound
040200	Dupont Storage
040300	Dupont Storage
040400	Dupont Storage
040500	Dupont Outbound
040600	Dupont Siding
040700	Dupont Storage
040800	Dupont Storage
040900	Dupont Storage
041000	Dupont Storage
041100	Dupont Storage
041200	Dupont Storage
041400	Oakley Siding

-23-

C.E. No. 11381 - SK Engineering Services - Topeta 2/91

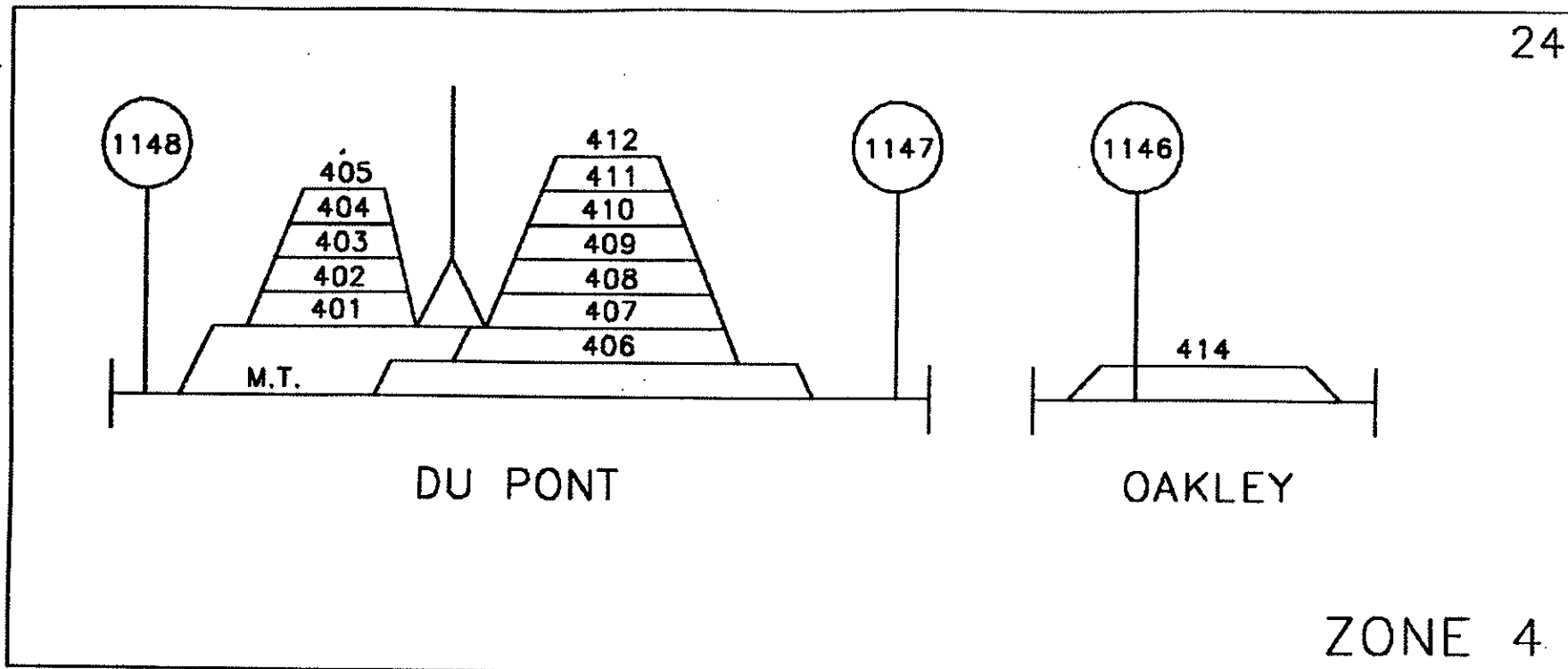

ZONE 4

051700	Sando Siding	053300	Yard	056200	Yard East Antioch
051800	Storage	053400	Western Tin Plate	056300	Yard East Antioch
051900	Kaiser Gypsum Dmtar	053500	Sando - East	056400	P.G. & E.
052000	Imperial West Chem.	053600	Antioch Link	056500	P.G. & E.
052100	Gaylord Container	053700	Plant 7 Lead	058100	Fulton Shipyard
052200	Gaylord Container	054000	Plant 7 Runaround	058200	Fulton Shipyard
052300	Gaylord Container	054100	Gaylord Container	058500	Sag Track
052400	Gaylord Container	054200	Gaylord Container	058600	Gaylord Container
052500	Gaylord Container	054300	Gaylord Container		
052600	Gaylord Container	054400	Gaylord Container		
052700	Gaylord Container	054500	Gaylord Container		
052800	ADK	054600	Gaylord Container		
052900	L&M Pallet	055000	Gaylord Container		
053000	L&M Pallet	055100	Gaylord Container		
053100	Yard	055200	Gaylord Container		
053200	Yard	056100	Yard East Antioch		

C.E. No. 11361 - SK Engineering Services - Topoka 2/91

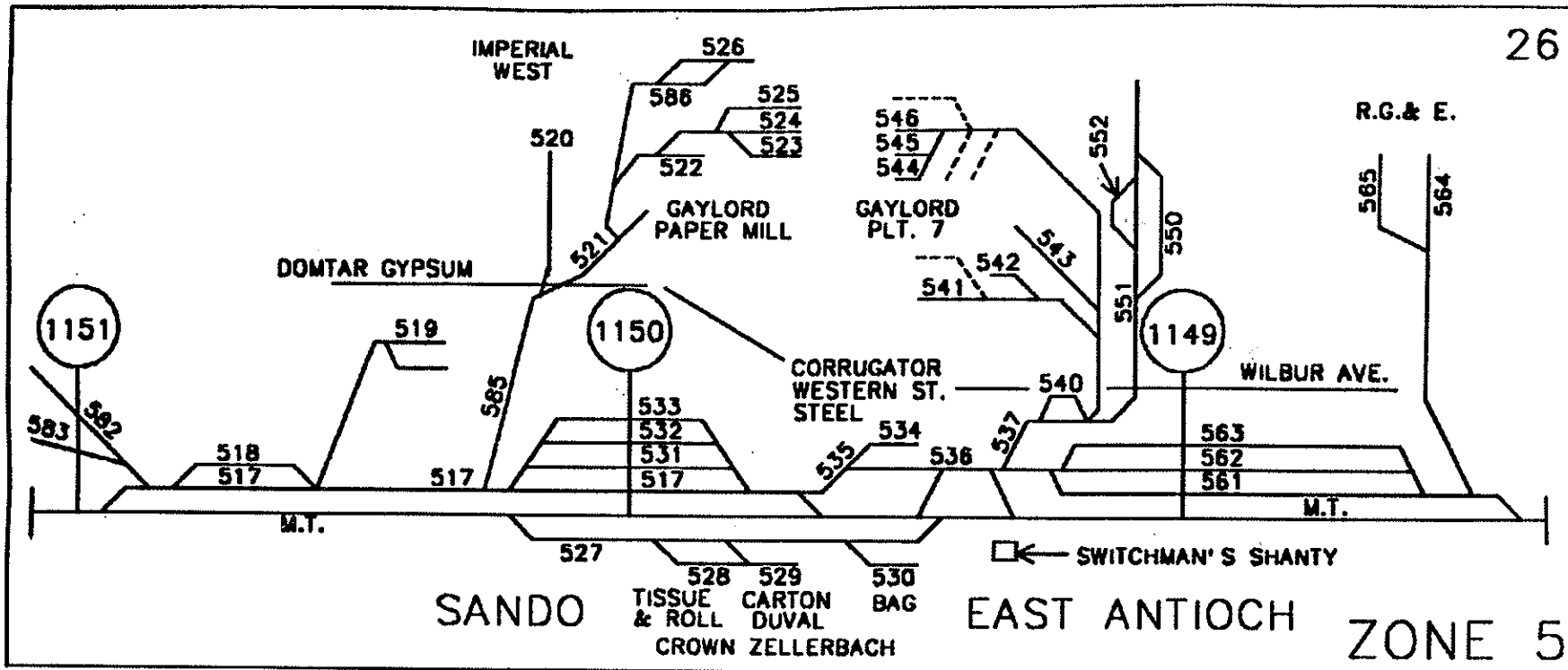

ZONE 5

- 050300 Lead and House
- 050400 Gaylord Container Box Plant
- 050500 Storage
- 050600 Glass Containers
- 050700 Glass Containers
- 050800 Storage
- 050901 Antioch 24
- 051200 Hickmott
- 051300 Storage
- 051400 Storage
- 051500 Storage
- 058000 Storage - Link
- 069800 Dow Runaround

-27-

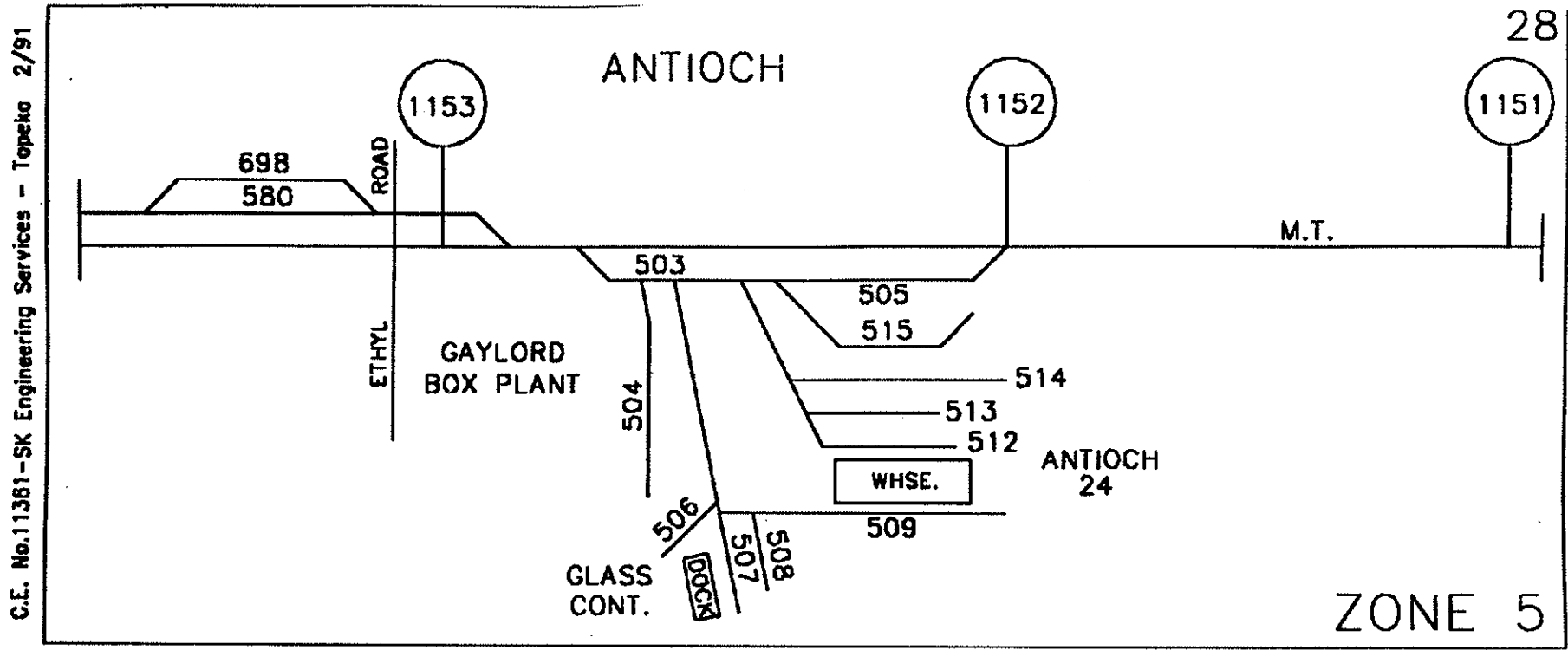

065301-04	Stauffer Chem.	067000	Dow Chemical	069300	Dow Chemical
065400	Feralloy Pipe Mill Lead	067100	Dow Chemical	069400	Dow Chemical
065501-02	Imperial West Chem.	067200	Dow Chemical	069500	Dow Chemical
065600	Imperial West Chem.	067300	Dow Chemical	069600	Dow Chemical
065700	Imperial West Chem.	067400	Dow Chemical	069700	Dow Chemical
065800	Specialinsup	067500	Dow Chemical	069800	500 Runaround
065901-02	Feralloy	067600	Dow Chemical		
066000	Dow Chemical	067700	Dow Chemical		
066100	Dow Chemical	067800	Dow Chemical		
066200	Dow Chemical	067900	Dow Chemical		
066300	Dow Chemical	068000	Dow Chemical		
066400	Dow Chemical	068100	Dow Chemical		
066500	Dow Chemical	068200	Dow Chemical		
066600	Dow Chemical	068300	Dow Chemical		
066700	Dow Chemical	068400	Dow Chemical		
066800	Dow Chemical	069100	Dow Chemical		
066900	Dow Chemical	069200	Dow Chemical		

C.E. No.11361-SK Engineering Services - Topeka 2/91

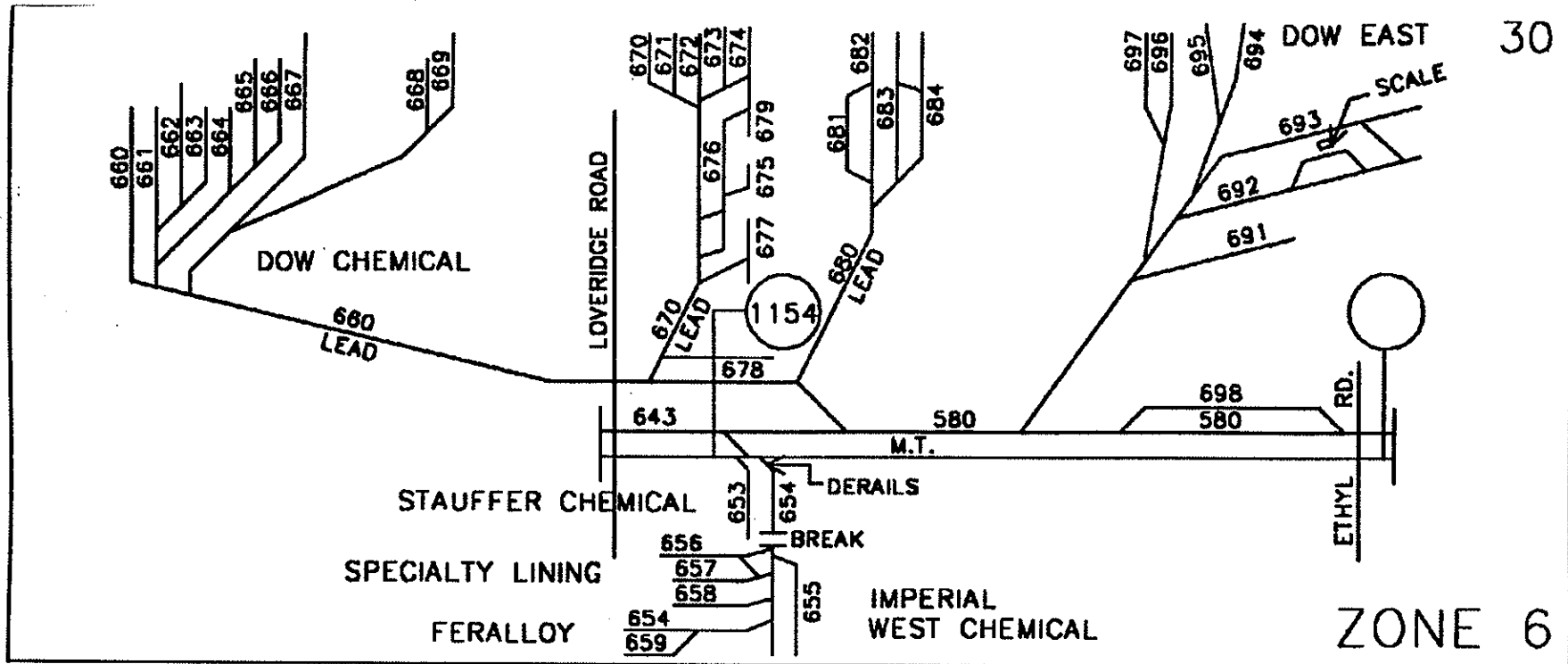

- 062000 Storage
- 062100 Yard 1
- 062200 Yard 2
- 062300 Yard 3
- 062400 Yard 4
- 062500 Yard 5
- 063000 Redwood Lead
- 063104 Johns-Mansville
- 063206 Johns-Mansville
- 063300 Johns-Mansville
- 063401 Johns-Mansville
- 063505 Johns-Mansville
- 063600 U.S.S. Wire Rope Scale
- 063700 U.S.S. Wire Rope Dock

- 063800 Running Track
- 063900 U.S.S. Inbound Excess
- 064000 U.S.S. Outbound
- 064100 Below Storage 4
- 064200 Below Storage 5
- 064300 Dow Running SN Main
- 064700 Diablo Seaways
- 065100 Cont. Litho
- 065200 Cont. Litho

-31-

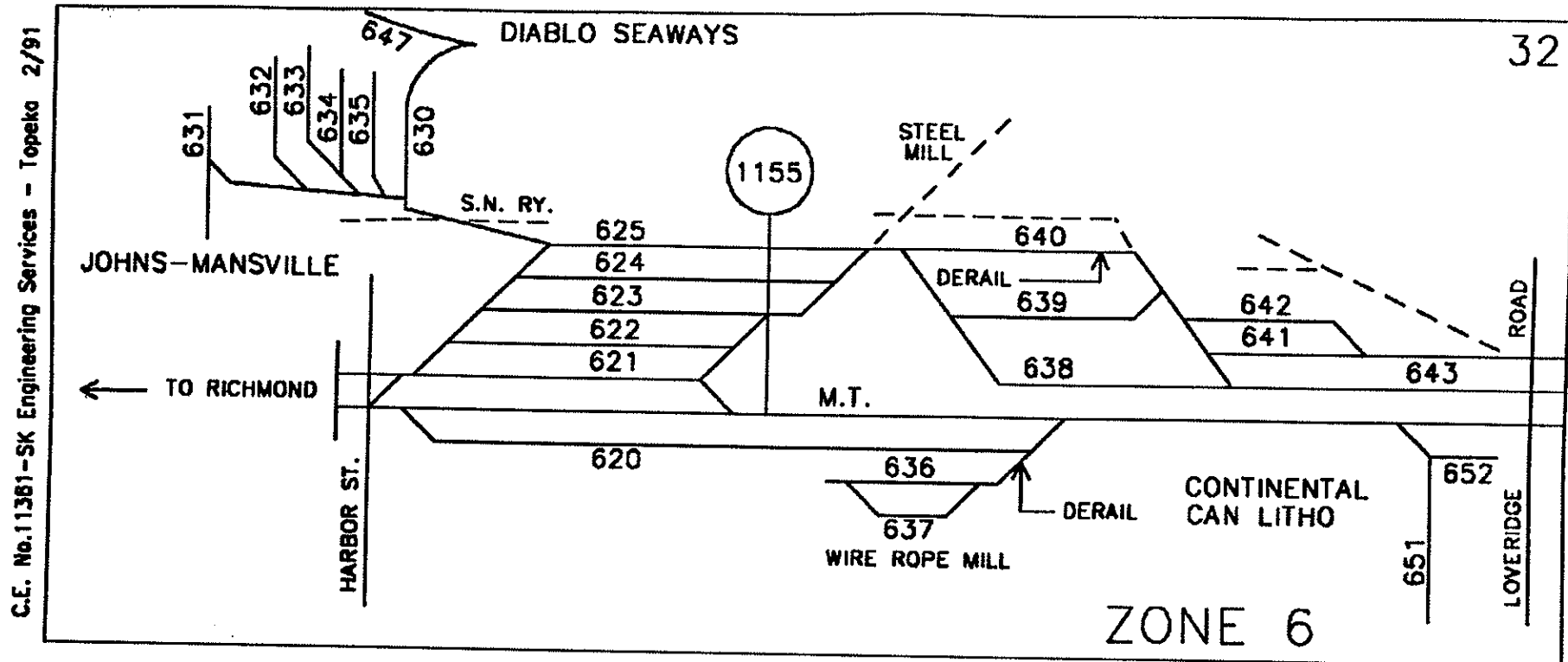

ZONE 6

ZONE 6

060200	Pittsburg Siding	061901	Pittsburg Whlse. Groc.
060300	North Lead	061902	Cumberland Lumber
060400	Cont. Fibre Drum	062600	Tail Track
060500	Cont. Fibre Drum	062700	Pitts House Track
060600	Santa Fe - S.P. Transfer	062800	Link Hill Yd. Ext.
060700	Santa Fe - S.P. Transfer	063000	Redwood Lead
060800	Santa Fe - S.P. Transfer		Johns Manville
060900	Santa Fe - S.P. Transfer		
061000	Santa Fe - S.P. Transfer		
061100	Back Track		
061200	Middle Track		
061300	Signode		
061400	Engine Spur		
061500	P. G. & E.		
061600	P. G. & E.		
061700	P. G. & E.		

-33-

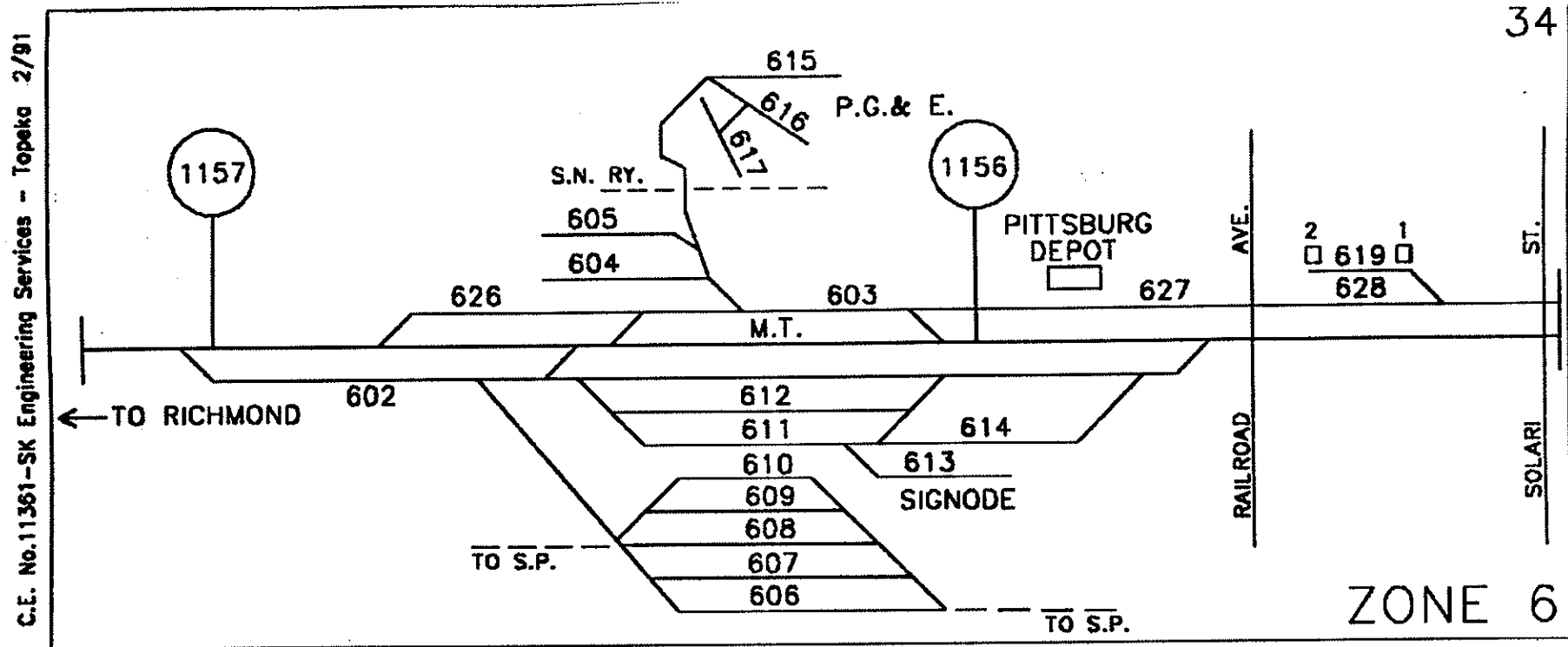

138000 Pt. Chicago Yard Siding
 138100 Pt. Chicago Yard Long 1
 138200 Pt. Chicago Yard Long 2
 138300 Pt. Chicago Yard Long 3
 138400 Pt. Chicago Yard
 138800 Short 1
 139800 U. S. Navy Bullpen
 139900 U. S. Navy Bullpen

-35-

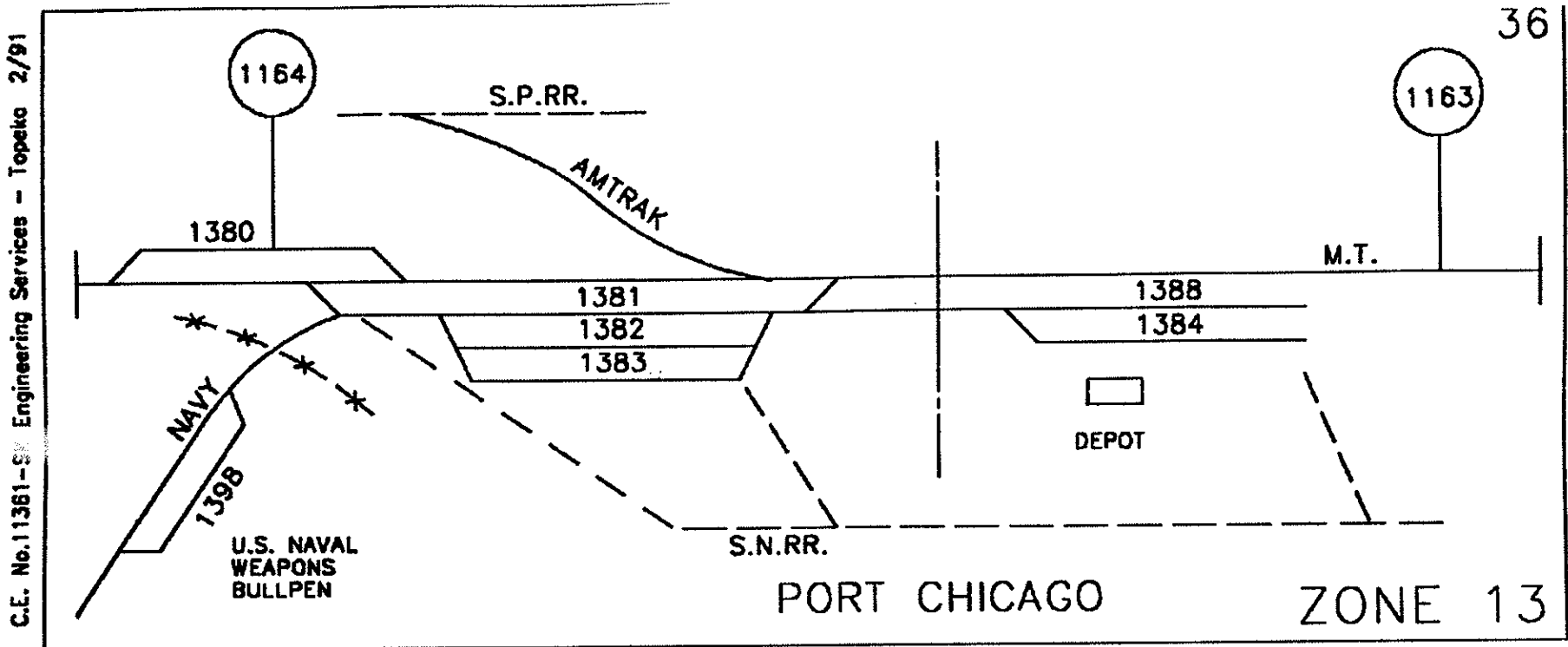

- 136500 Tosco Refinery Coker
- 136600 Tosco Refinery Catalyst
- 136700 Tosco Refinery
- 136900 Liquid Carbonics
- 137000 Monsanto Siding
- 137100 Acid Spur
- 137300 Monsanto Chemical Warehouse Dock
- 137500 Tosco Chemical
- 137600 Monsanto Chemical Acid Tank Car

-37-

C.E. No. 11361-SK Engineering Services - Topeka 2/91

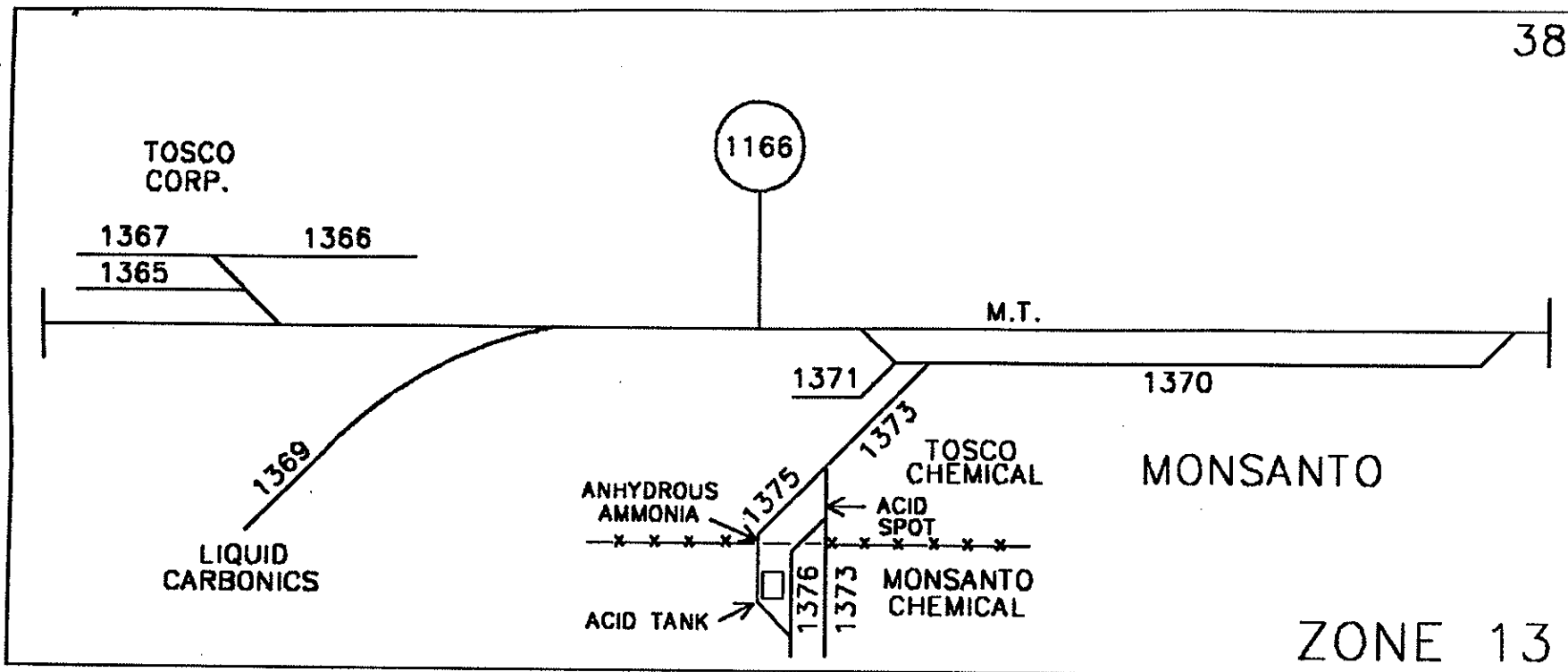

134900	Maltby Siding
135000	Tosco Refinery
135100	Tosco Refinery
135300	Contra Costa Sanitary
135400	Contra Costa Sanitary
135500	Contra Costa Sanitary
135700	Contra Costa Sanitary
135900	Contra Costa Sanitary
136000	Contra Costa Sanitary
136100	Contra Costa Sanitary
136200	Contra Costa Sanitary
136300	Contra Costa Sanitary

-39-

C.E. No. 11361-SK Engineering Services - Topoka 2/91

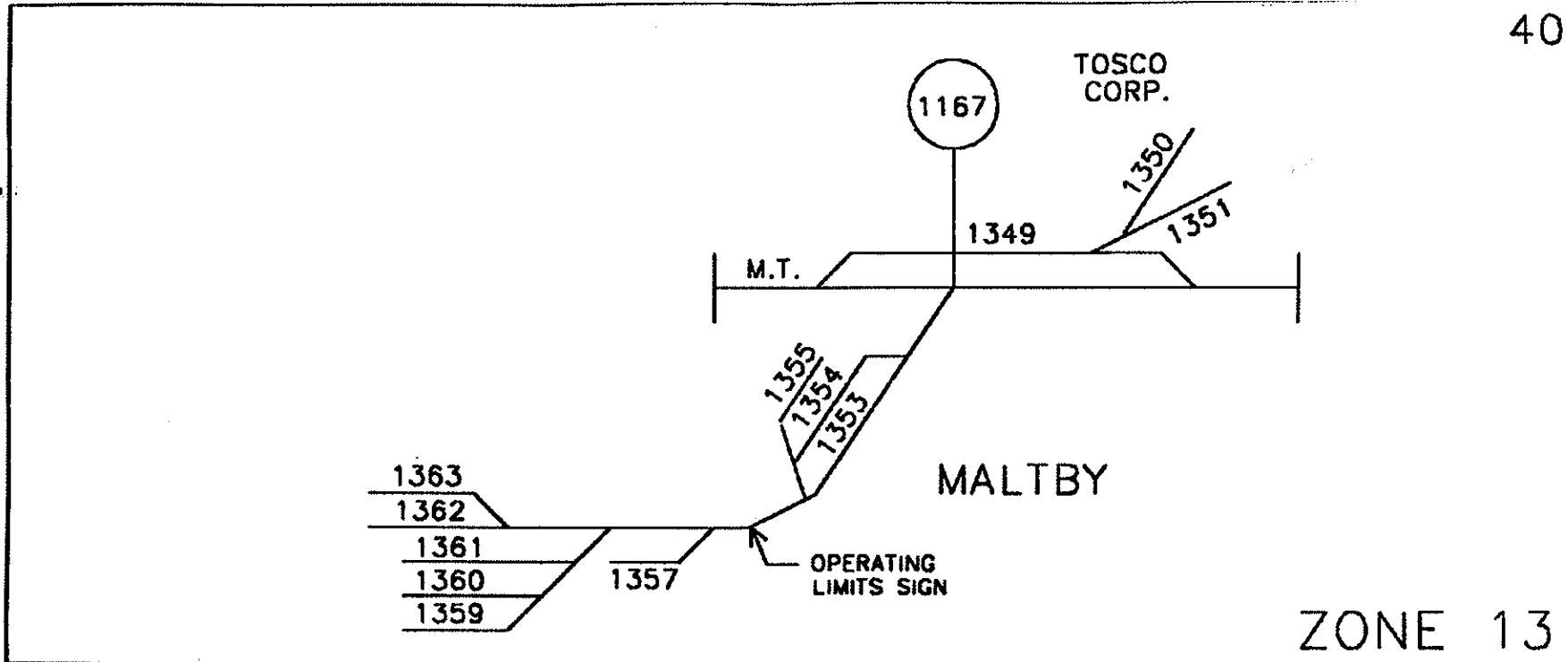

133501-06 Asbury Graphite
 133590 Loprest Co.
 133800 Christie Siding
 134000 Storage
 134100 Storage
 134200 Glen Frazer Siding

-41-

C.E. No. 11561-SK Engineering Services - Topoka 2/91

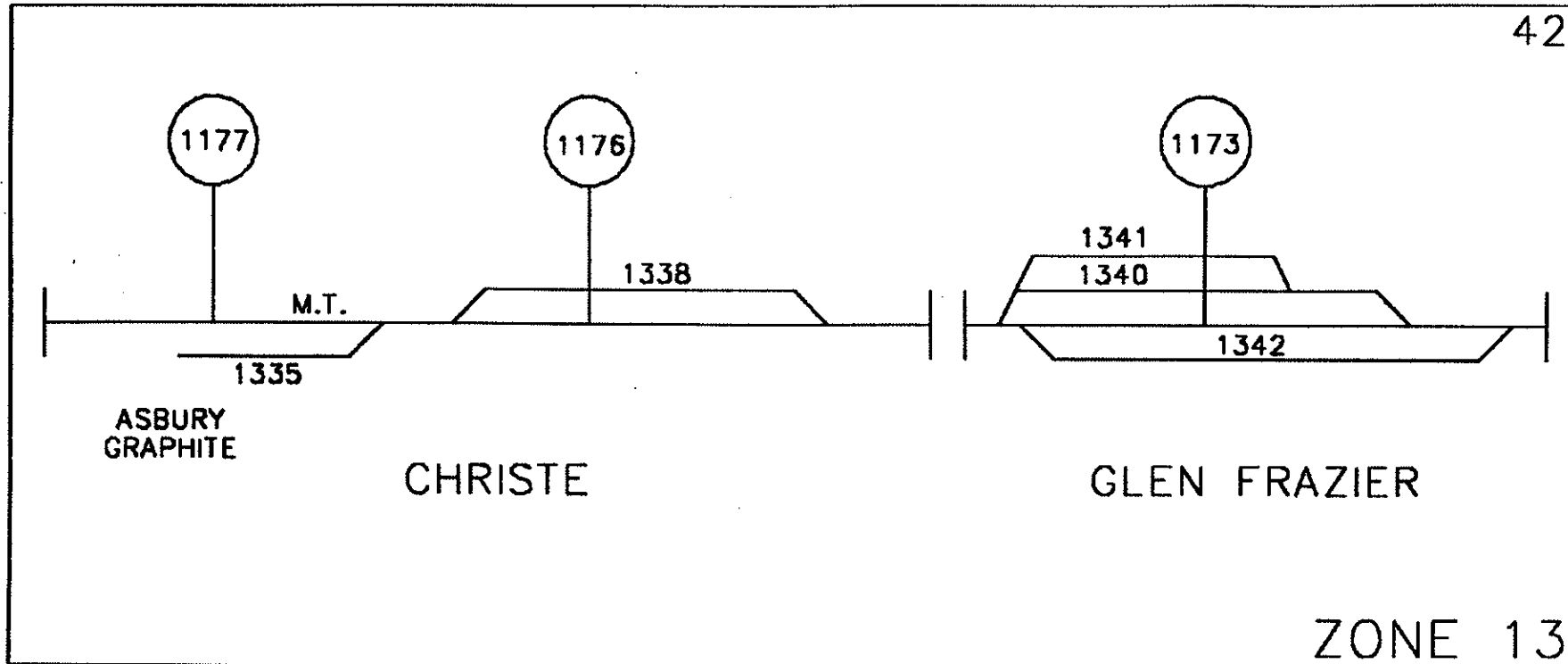

- 132300 Gateley Siding
- 132700 Pinole House Track
- 132800 Collier Siding
- 133000 Storage
- 133191 Collier Carbon
- 133290 Collier Carbon
- 133390 Collier Carbon

-43-

C.E. No. 11361-SK Engineering Services - Topoko 2/91

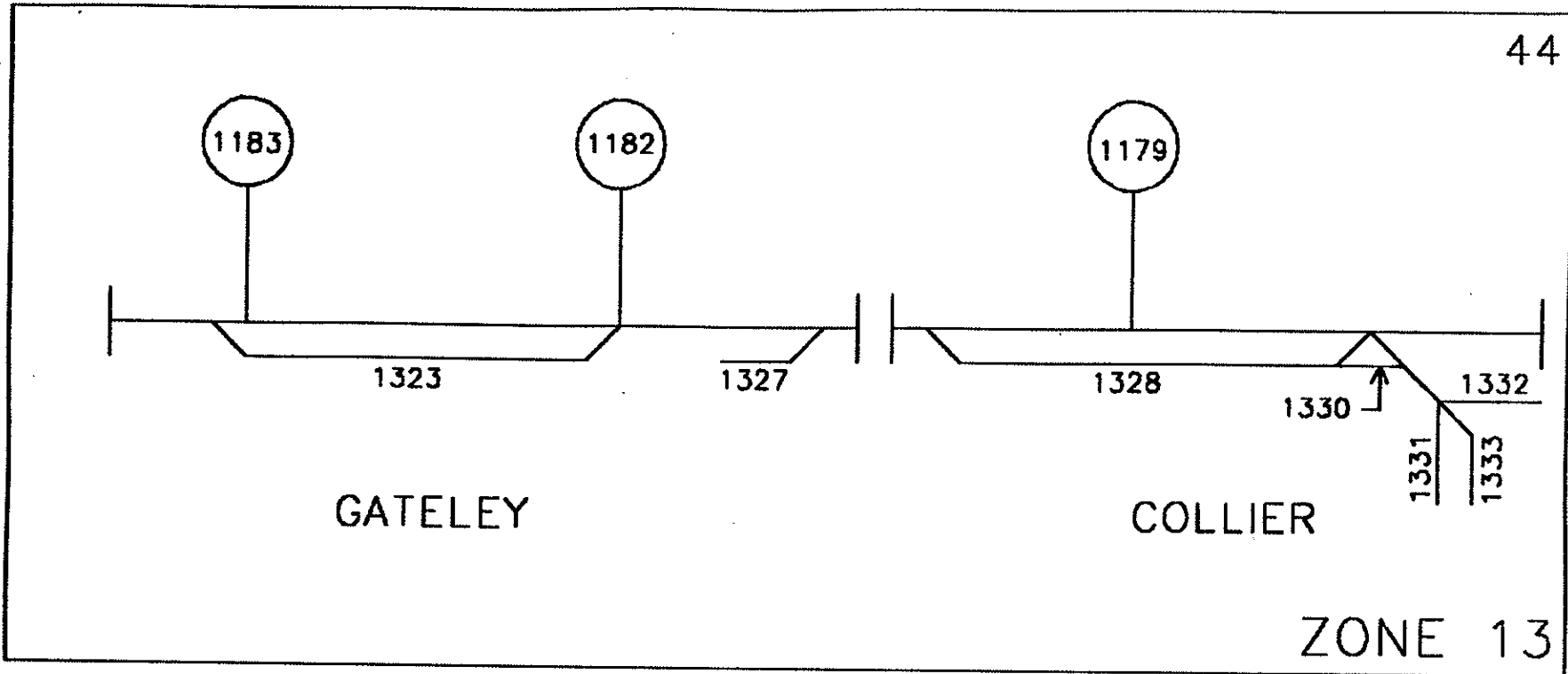

130100 S. P. Lead
 130200 Rheem Siding
 130300 Vacant
 130400 Atlas Foundry
 130607-08 American Standard
 130701-90 Acme Transportation
 130900 American Standard
 131200 Storage
 131390-92 Bethlehem Steel
 131490-92 Bethlehem Steel
 131590-92 Bethlehem Steel
 131690-92 Bethlehem Steel
 131790-92 Bethlehem Steel
 131990-92 Bethlehem Steel
 132090-92 Bethlehem Steel
 132190-92 Bethlehem Steel
 132200 Storage

UPS NORTH BAY FACILITY
 1312 Siding
 1314 West End Strip Track 1
 1315 East End Strip Track 2
 1316 West End Strip Track 2
 1318 Donico Company

0058v

-45-

