

# **Santa Fe**



## **Dublin District Northern Division Bulletin 3**

### **Trackage Diagrams**

**July 1, 1980**

**Prepared by David W. Moore  
Information from ATSF Car Location Identity Codes (CLIC)**

**CLIC Instructions** – This booklet contains instructions and maps for Car Location Identity Code (CLIC).

Maps are not drawn to scale and are to be used only as a guide to locating customer and yard tracks and the numbers assigned to them. The geographical area covered in this booklet is divided into zones. Each zone has designated tracks and/or industries within its boundary.

A CLIC number will consist of six digits. The first two digits designate the zone, the second two digits indicate the track number within the zone, the last two digits represent the actual spot along the track.

All switch targets or stands have been painted with a combination of the zone and track number. Spot numbers have been painted on doors, docks, buildings, gates, etc., wherever possible.

Index of maps. Click on the link to go to that map.

[Zone 70 Page 2](#) – Waples

[Zone 70 Page 4](#) – Granbury

[Zone 70 Page 6](#) – De Cordova Spur

[Zone 70 Page 8](#) – Tolar

[Zone 70 Page 10](#) – Bluffdale

[Zone 70 Page 12](#) – Immermere

[Zone 70 Page 14](#) – Stephenville

[Zone 70 Page 16](#) – Dublin

[Zone 70 Page 18](#) – Proctor

[Zone 70 Page 20](#) – Comanche

[Zone 70 Page 22](#) – Centex

[Zone 70 Page 24](#) – Blanket

[Zone 70 Page 26](#) – Delaware

[Zone 70 Page 28](#) – Ricker

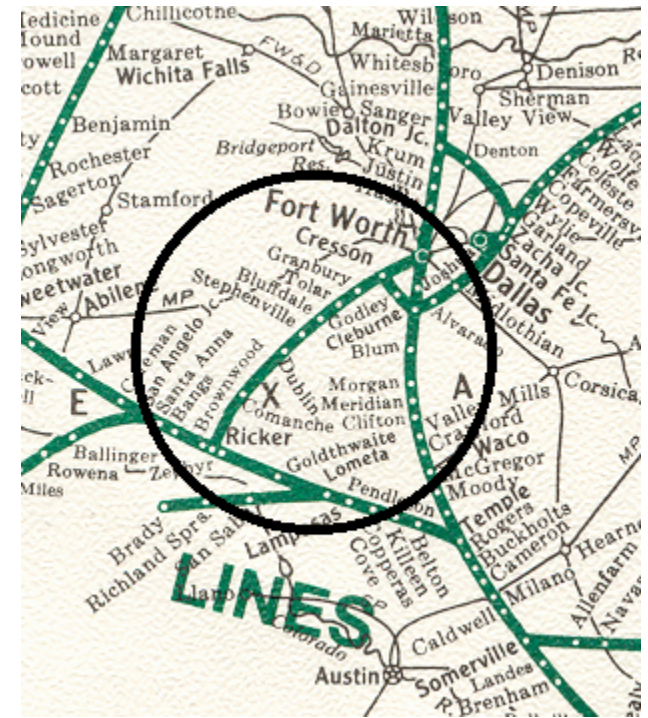

ZONE 70 (WAPLES 22030) DUBLIN DISTRICT

709900 WAPLES MAIN TRACK  
700100 WAPLES SIDING (7100 FT)

PAGE ONE

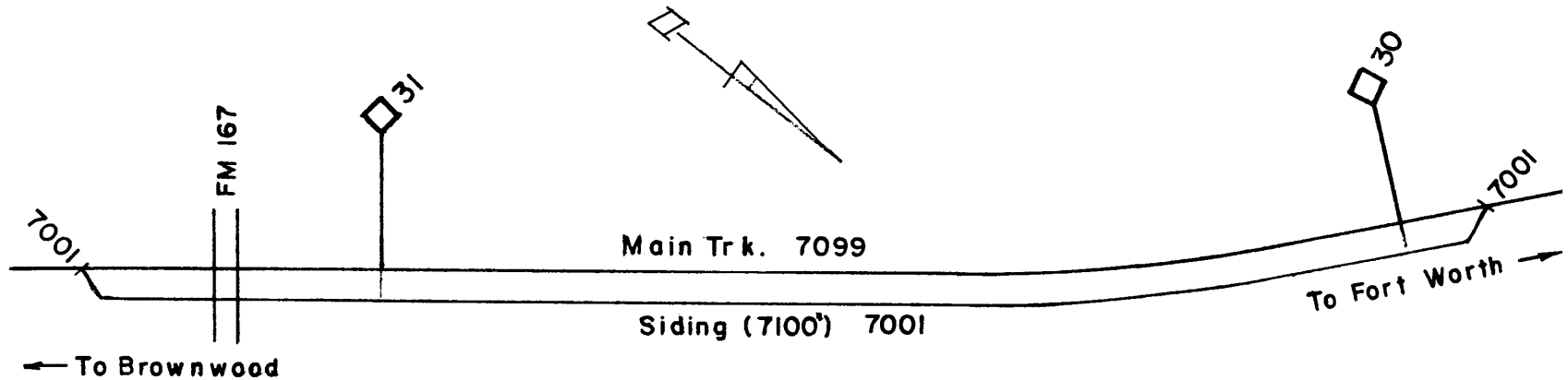

ZONE 70

WAPLES

PAGE 2

ZONE 70 <GRANBURY 22036> DUBLIN DISTRICT

709900	GRANBURY MAIN TRACK	
700200	GRANBURY INDUSTRY TRACK	
01	GRANBURY BOND FEED	PLATFM 01
02	GRANBURY BOND FEED	PLATFM 02
03	GRANBURY BOND FEED	SPOUT 01
04	GRANBURY BOND FEED	SPOUT 02
05	GRANBURY BOND FEED	SPOUT 03
06	GRANBURY HOOD CO AGRI	NOZZLE (LIQUID FERTZ)

PAGE 3

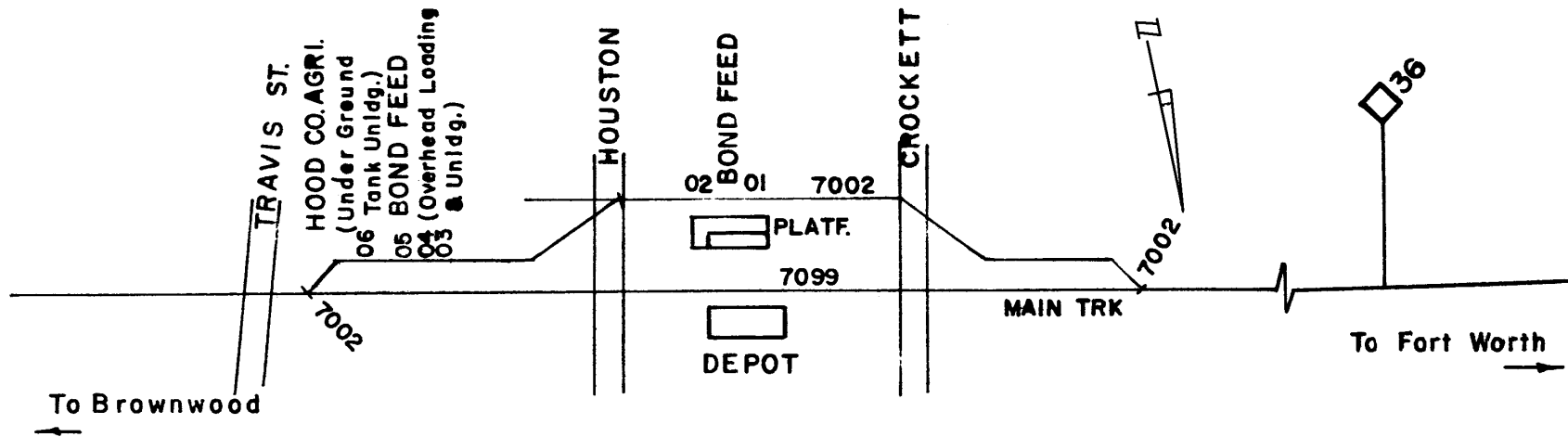

GRANBURY

ZONE 70

PAGE 4

ZONE 70 <DE CORDOVA 22042> DUBLIN DISTRICT

709900 DE CORDOVA MAIN TRACK  
700300 DE CORDOVA TEX POWER & LIGHT SPUR

PAGE 5

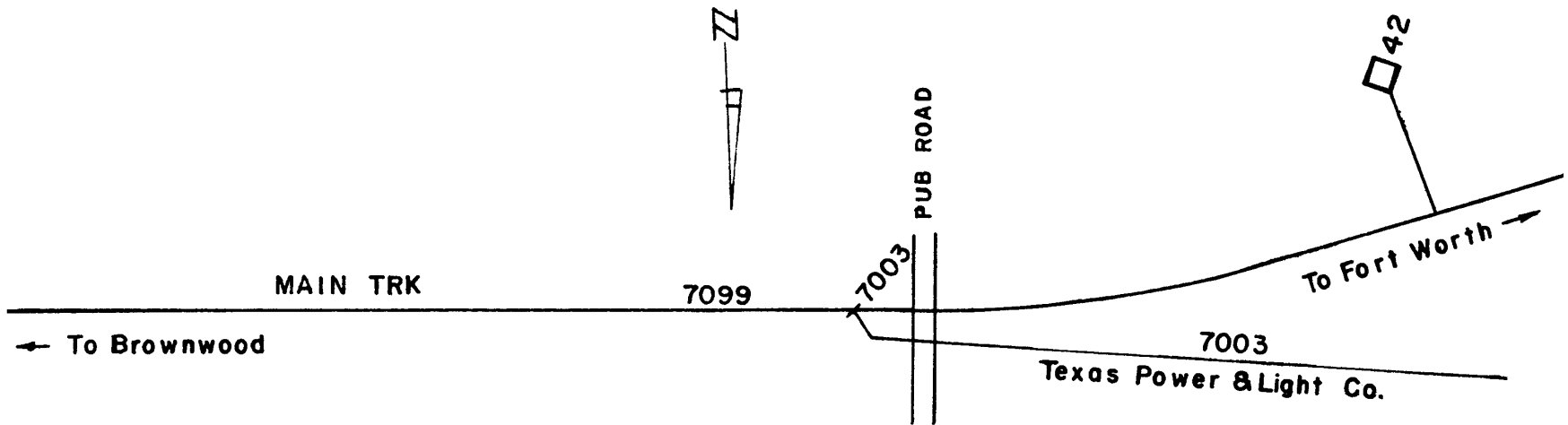

DE CORDOVA SPUR <sup>ZONE 70</sup>

PAGE 6

ZONE 70 (TOLAR 22046) DUBLIN DISTRICT

- 709900 TOLAR MAIN TRACK
- 700400 TOLAR SIDING TRACK
- 700500 TOLAR HOUSE TRACK
- 700600 TOLAR TEX UTILITIES SPUR
- 700700 TOLAR RUN-A-ROUND TRACK

PAGE 7

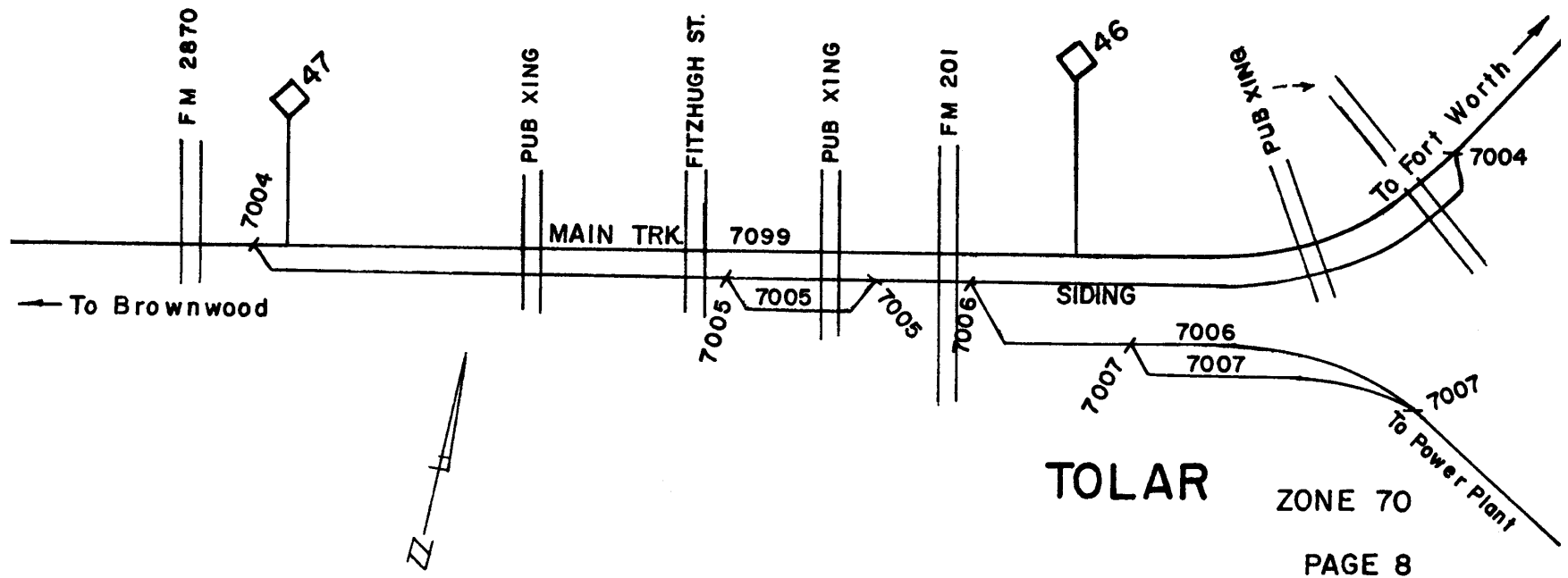

ZONE 70

PAGE 8

ZONE 70 <BLUFFDALE 22055> DUBLIN DISTRICT

709900 BLUFFDALE MAIN TRACK  
700800 BLUFFDALE SIDING (600 FT)

PAGE 9

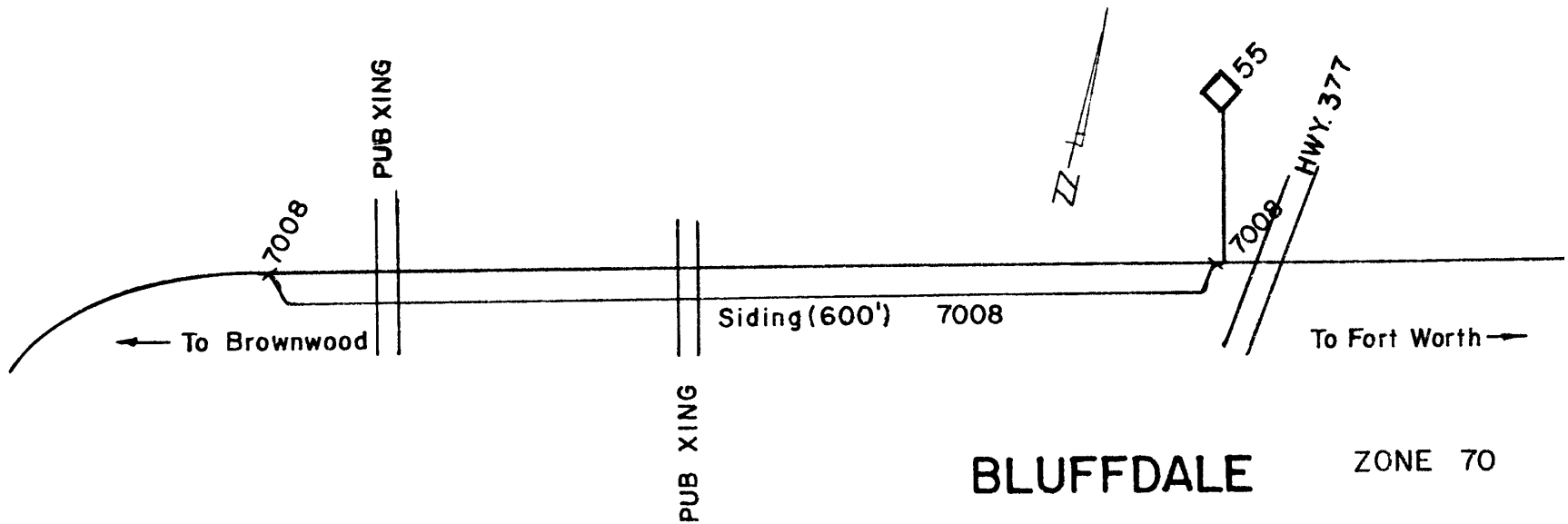

BLUFFDALE

ZONE 70

PAGE 10

ZONE 70 (IMMERMERE 22062) DUBLIN DISTRICT

709900 IMMERMERE MAIN TRACK  
700900 IMMERMERE SIDING (7600 FT)

PAGE 11

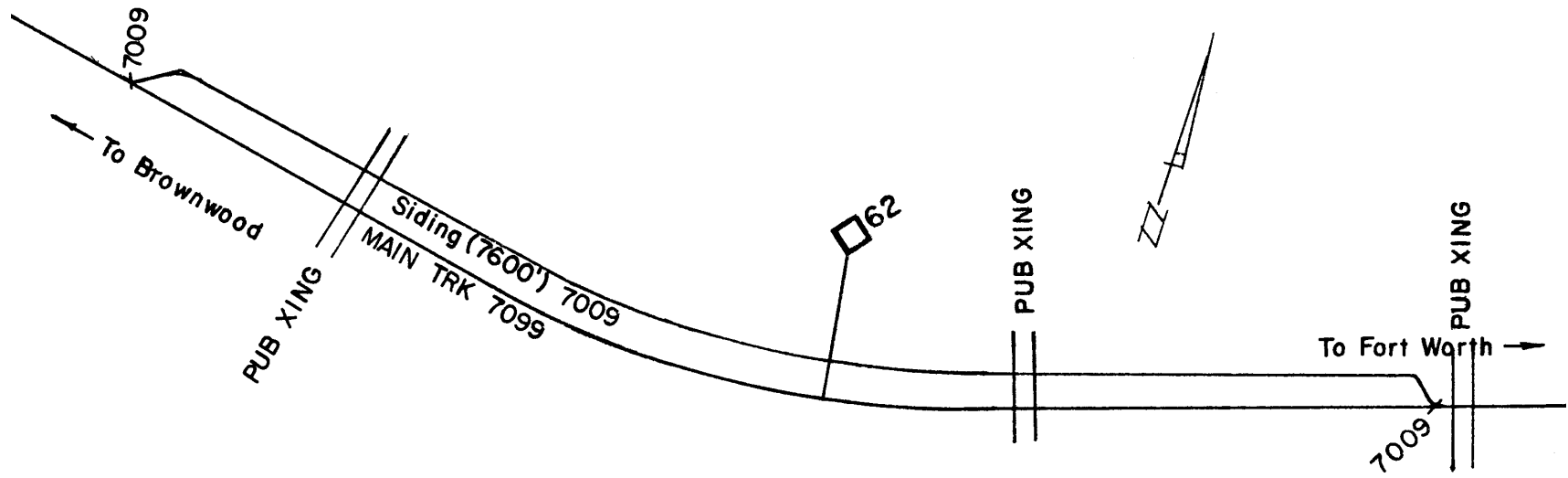

IMMERMERE

ZONE 70  
PAGE 12



ZONE 70 (STEPHENVILLE 22072)  
DUBLIN DISTRICT

709900	STEPHENVILLE MAIN TRACK
701000	POSTON FEED MILL TRACK
01	POSTON FEED MILL DOOR
02	POSTON FEED MILL DOOR
03	POSTON FEED MILL U.T.PIT
04	POSTON FEED MILL OPEN AREA
05	POSTON FEED MILL OPEN AREA
06	POSTON FEED MILL OPEN AREA
701400	KIMBELL TRACK
01	POSTON FEED MILL TANK LDG
02	POSTON FEED MILL DOOR
03	POSTON FEED MILL DOOR
701200	STEPHENVILLE SHORT SIDING
701300	STEPHENVILLE HOUSE TRACK
01	ERATH FERTZ CO DOOR
701400	STEPHENVILLE TEAM TRACK
01	ERATH FERTZ CO U.T.PIT
02	G.S.E., INC U.T.PIT
03	G.S.E., INC DOOR
04	G.S.E., INC DOOR
701500	STEPHENVILLE MILL SPUR
701600	STEPHENVILLE MILL TRACK
01	ERATH FERTZ O.H.LDG
02	ERATH FERTZ DOOR
03	FARMERS MILLING U.T.PIT
04	FARMERS MILLING DOOR
05	BIRD SONG PEANUT O.H.LDG
701700	STEPHENVILLE PIT TRACK
701800	STEPHENVILLE MIDDLE TRACK
01	STEPHENVILLE RAMP RAMP
701900	STEPHENVILLE TEXACO TRACK
01	ANDERSON FEED MILL DOOR
02	ANDERSON FEED MILL DOOR
702000	STEPHENVILLE SIDING(9000 FT)
702100	COOK LUMBER SPUR
01	COOK LUMBER CO OPEN
02	COOK LUMBER CO DOOR
702200	STEPHENVILLE INDUSTRIAL TRK
702300	CAPORAL STEEL SPUR TRACK
01	CAPORAL STEEL OPEN
02	CAPORAL STEEL OPEN
03	CAPORAL STEEL OPEN
04	CAPORAL STEEL OPEN

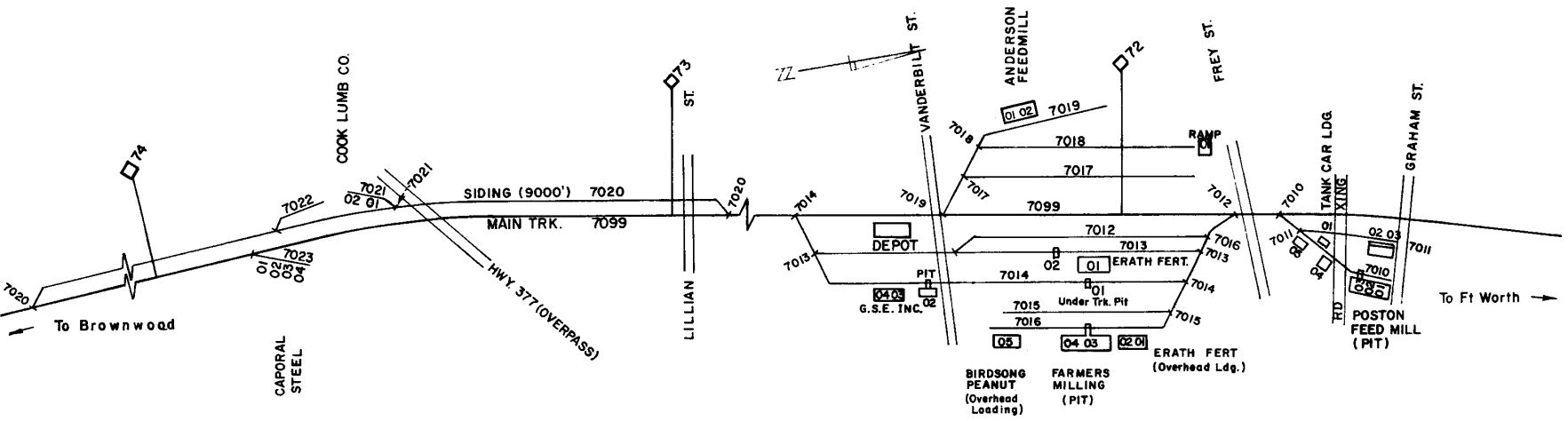

STEPHENVILLE

ZONE 70 <DUBLIN 22085> DUBLIN DISTRICT

709900 DUBLIN MAIN TRACK  
 702400 DUBLIN SIDING (5900 FT)  
 702500 DUBLIN MILL TRACK  
     01 DUBLIN WOLDERT PEANUT CO DOOR  
     02 DUBLIN WOLDERT PEANUT CO DOOR  
 702600 DUBLIN SPUR TRACK  
 702800 DUBLIN YARD TRACK NO.1  
 702900 DUBLIN YARD TRACK NO.2  
 703000 DUBLIN YARD TRACK NO.3  
 703100 DUBLIN HOUSE TRACK  
 703200 DUBLIN TEX CEN INTERCHGE TRACK  
 703300 DUBLIN COMPRESS TRACK  
     01 DUBLIN HENDERSON SALES DOOR

PAGE 15

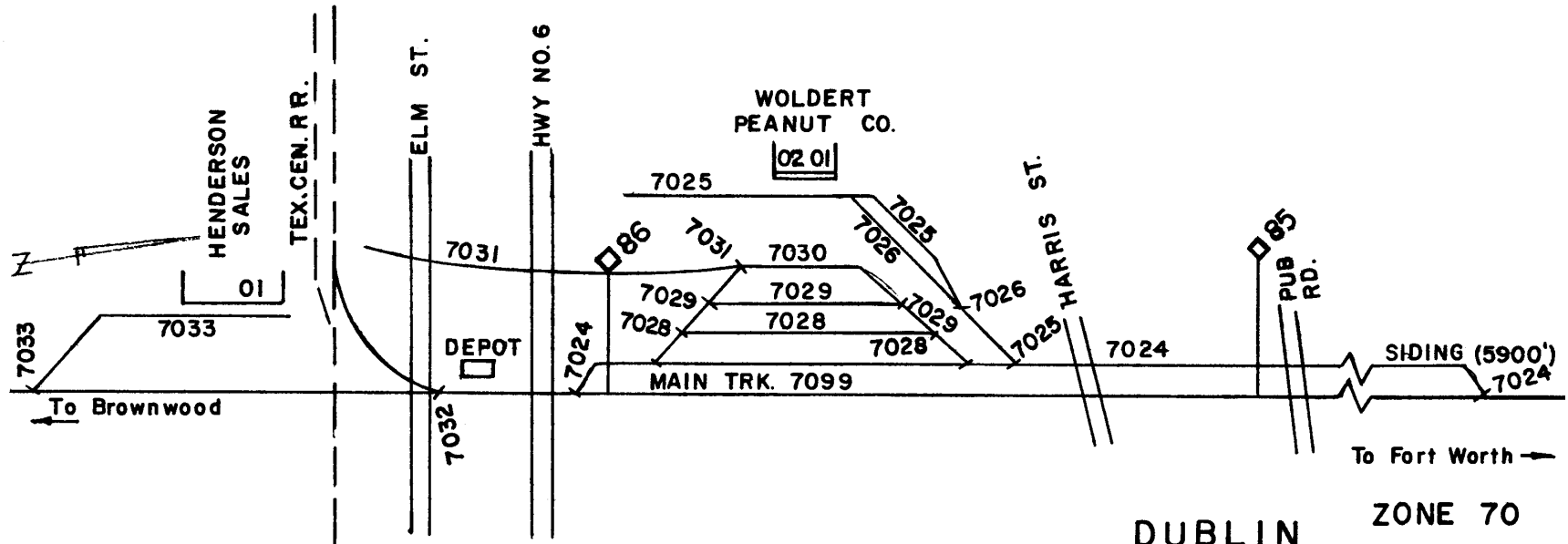

DUBLIN

ZONE 70

PAGE 16

ZONE 70 (PROCTOR 22095) DUBLIN DISTRICT

- 709900 PROCTOR MAIN TRACK
- 703500 PROCTOR SIDING (7800 FT)
- 703600 PROCTOR TERM TRACK
- 01 PROCTOR DELEON PEANUT CO O.H.SPOUT

PAGE 17

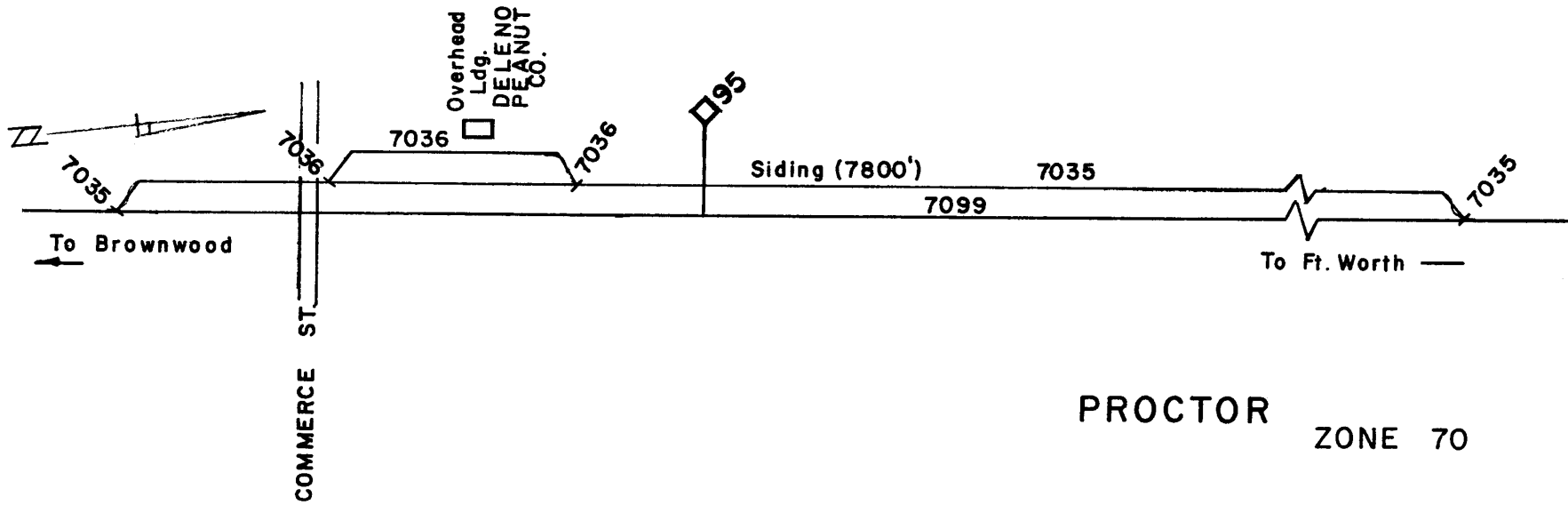

PROCTOR ZONE 70

PAGE 18

ZONE 70 (COMANCHE 22408)  
DUBLIN DISTRICT

709900	02	COMANCHE MAIN TRACK	
704000	02	COMANCHE SIDING (7700 FT)	
704100	04	COMANCHE GORES TRACK	
01	04	GORES BROS FEED	DOOR
02	02	GORES BROS FEED	U.T.PIT
704200	01	COMANCHE DURHAM SPUR	
01	04	GOLD KIST	DOOR
02	02	GOLD KIST	NO UNLDG
704300	02	COMANCHE SHORT SIDING	
704400	04	COMANCHE TEAM TRACK	
01	04	TEAM UNLOADING	OPEN TRACK
704500	04	COMANCHE SHORT HOODO TRACK	
704600	04	COMANCHE HOODO TRACK	
01	04	GOLD KIST	DOOR
704614	02	COMANCHE SEED & FEED	DOOR
704700	04	COMANCHE TURKEY TRACK	
01	04	HIGGINBOTHAM	GATE
02	02	HIGGINBOTHAM	GATE
704800	02	COMANCHE OLD MOORMAN TRACK	
01	04	MOORMAN'S FEEDS	U.T.PIT
02	02	MOORMAN'S FEEDS	U.T.PIT
03	03	MOORMAN'S FEEDS	DOOR
04	04	MOORMAN'S FEEDS	DOOR
05	05	MOORMAN'S FEEDS	DOCK
704900	04	COMANCHE NEW MOORMAN TRACK	
01	04	MOORMAN'S FEEDS	U.T.PIT

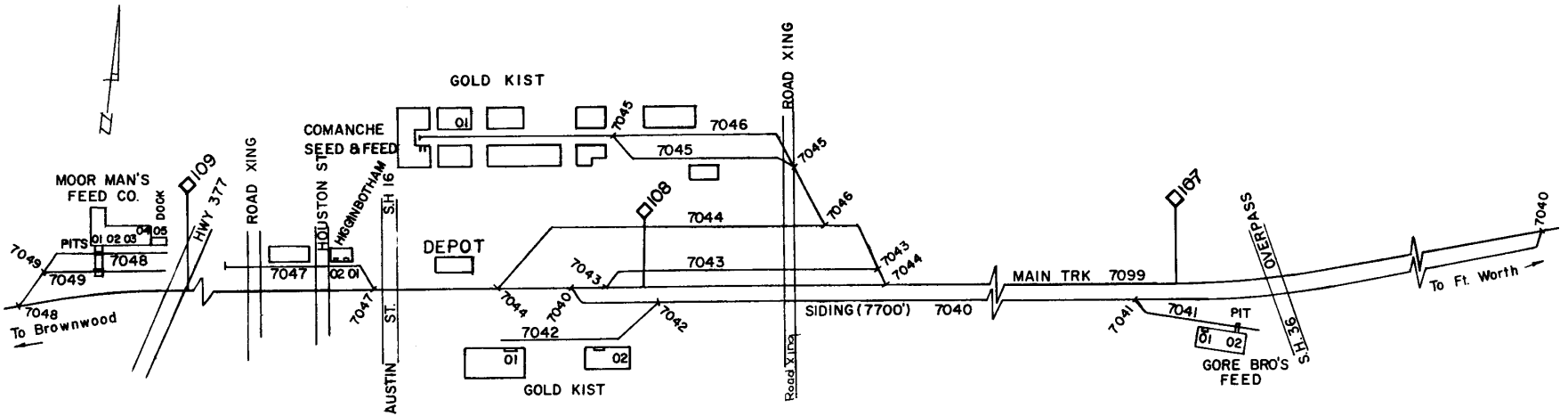

ZONE 70 (CENTEX ) DUBLIN DISTRICT

709900 CENTEX MAIN TRACK  
705000 CENTEX INDUSTRIAL TRACK  
01 CENTEX AMERICAN PLANT FOOD U.T.PIT

PAGE 21

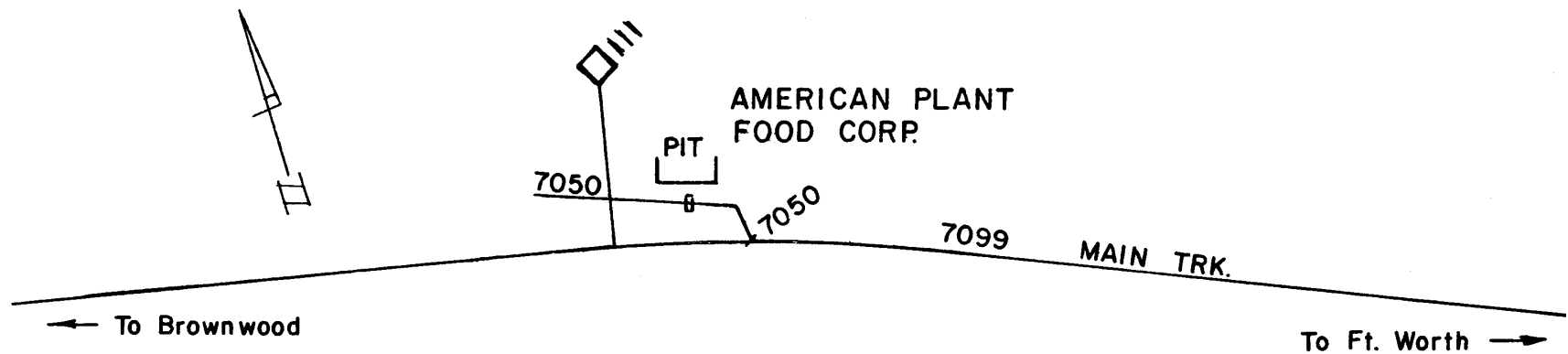

CENTEX      ZONE 70  
PAGE 22

ZONE 70 (BLANKET 22424) DUBLIN DISTRICT

709900 BLANKET MAIN TRACK  
705300 BLANKET SIDING (4100 FT)  
705400 BLANKET HOUSE TRACK

PAGE 23

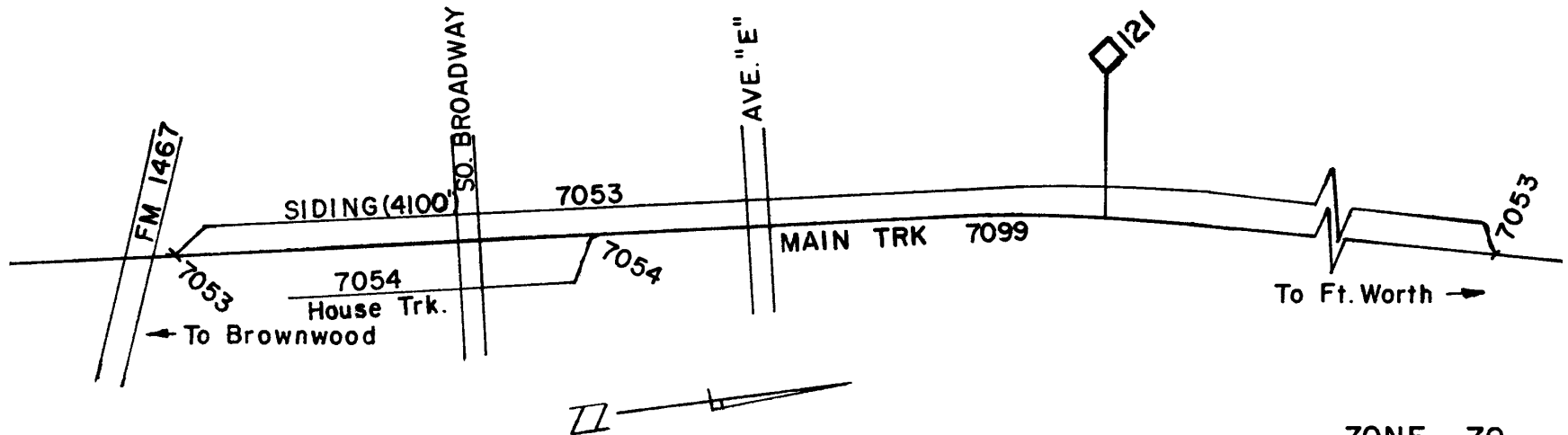

BLANKET

ZONE 70

PAGE 24

ZONE 70 (DELAWARE ) DUBLIN DISTRICT

709900 DELAWARE MAIN TRACK  
705600 DELAWARE SIDING (8000 FT)

PAGE 25

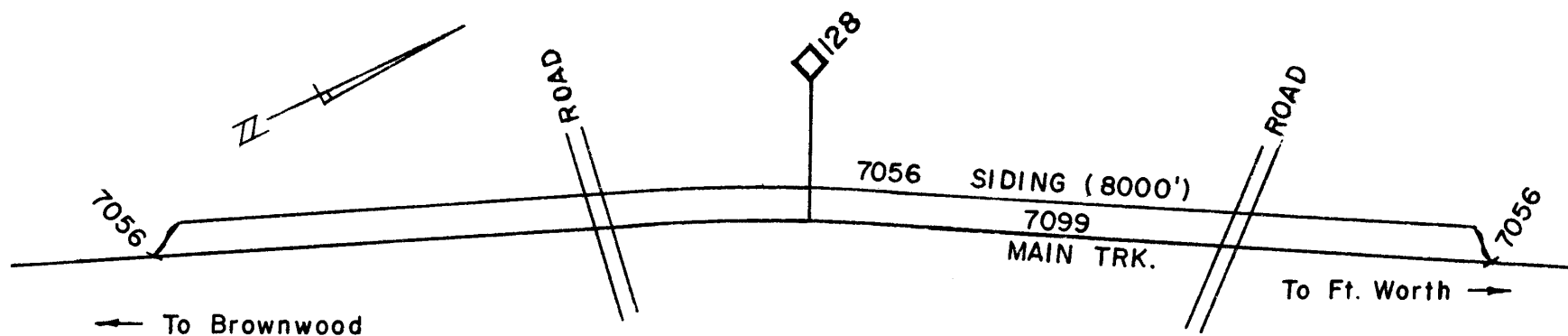

DELAWARE ZONE 70  
PAGE 26

ZONE 70 (RICKER ) DUBLIN DISTRICT

709900 RICKER MAIN TRACK  
705800 RICKER SIDING (5700 FT)

PAGE 27

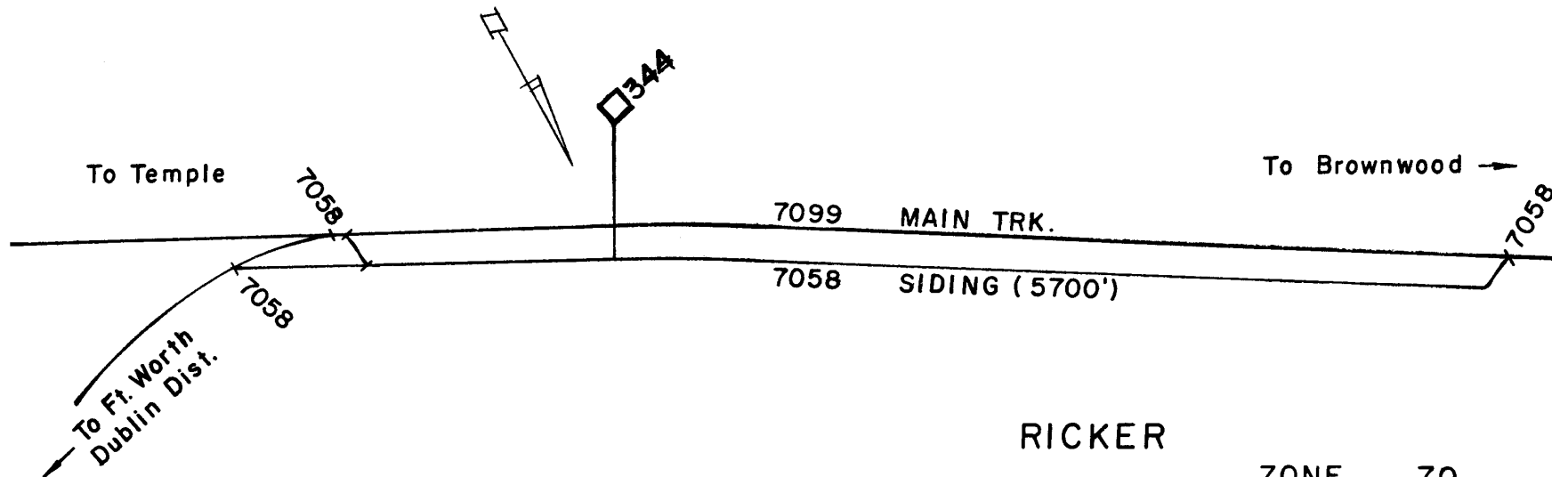

RICKER

ZONE 70

PAGE 28